

Université de Montréal

Modélisation spatio-temporelle orientée-objet  
pour l'étude du comportement de transport basé sur l'activité

par

Ali Frihida

Département de géographie  
Faculté des arts et des sciences

Thèse présentée à la Faculté des études supérieures

En vue de l'obtention du grade de

*Philosophiæ Doctor* (Ph.D.)

Décembre 2001

© Ali Frihida, 2001



G  
59  
U54  
2002  
N.006

2002  
U54  
N.006

Université de Montréal  
Faculté des études supérieures

Cette thèse intitulée :  
Modélisation spatio-temporelle orientée-objet  
pour l'étude du comportement de transport basé sur l'activité

présentée par :

Ali Frihida

a été évaluée par un jury composé des personnes suivantes:

William J. Coffey  
président-rapporteur

Danielle J. Marceau  
directeur de recherche

Marius Thériault  
co-directeur

Martin-Lee Gosselin  
membre du jury

Christophe Claramunt  
examineur externe

  
représentant du doyen de la FES

## Résumé

Cette étude fait partie d'un vaste programme de recherche multidisciplinaire dans le domaine de la modélisation du transport dont le principal but est l'analyse des patrons de déplacement individuel afin de faciliter la planification du transport urbain. L'objectif de cette étude est la conception, le développement et l'implantation d'une base de données spatio-temporelle du comportement de transport basé sur l'activité. Elle doit être en mesure de modéliser le comportement désagrégé de transport avec un minimum de perte sémantique et ce, par la modélisation des propriétés et du comportement des entités spatio-temporelles et par la modélisation des relations simples et complexes tissées entre les entités. Cette base de données doit aussi gérer facilement les requêtes spatio-temporelles afin d'opérer comme serveur de données qui fournit une infrastructure aux modèles de prévision et de simulation du transport urbain. Finalement, elle doit permettre l'affichage et la visualisation des données.

Pour réaliser cet objectif, la géographie temporelle a été utilisée comme cadre pour l'analyse du domaine de l'application. La méthodologie orientée-objet a servi à la conception du modèle de données qui a été implanté dans le prototype d'une base de données hébergée par la coquille Smallworld GIS™. Le prototype a été peuplé par des échantillons de données provenant de trois sources. La première est une enquête origine-destination (O-D) réalisée en 1991 dans la région de Québec, au Canada, par la Société de transport de la Communauté urbaine de Québec (STCUQ). La seconde source est la localisation des lieux d'activités selon le système de conversion des

codes postaux de Statistiques Canada. La troisième est le réseau routier de la ville de Québec.

Des requêteurs temporels et de position ont été conçus et développés pour gérer les requêtes spatio-temporelles et les requêtes adressées à la trajectoire spatio-temporelle. Une interface basée sur Visual Basic™ a été implantée afin de permettre l'affichage et l'animation cartographique des données.

Le prototype répond adéquatement aux spécifications initiales du projet. Les résultats sont une contribution à la modélisation multidimensionnelle du comportement de transport basé sur l'activité. Ils enrichissent les approches cherchant à intégrer efficacement l'espace et le temps par l'opérationnalisation des concepts clés de la géographie temporelle.

Les développements conceptuels et géo-informatiques de cette étude peuvent être enrichis par des recherches comme l'intégration des requêteurs standard et temporels, la conception de langage de scripting pour l'animation cartographique et les agents spatiaux intelligents. Il est aussi possible d'appliquer les résultats à d'autres domaines comme la géographie de la santé, la biographie, l'archéologie, l'utilisation du sol, le système de cadastre, la foresterie ou l'aménagement urbain.

**Mots clés :**

Modélisation spatio-temporelle, paradigme orienté-objet, base de données spatio-temporelles, requête temporelle positionnelle, trajectoire spatio-temporelle, comportement de déplacement basé sur l'activité, animation cartographique.

## **Abstract**

This study is a part of a long-term multidisciplinary transportation research project which main purpose is to analyze and model disaggregate travel behavior in order to support urban transportation planning. The objective of this study is the conception and the development of an activity-based travel behavior spatio-temporal database. The database should be able to model disaggregate travel behavior with minimal semantic loss by taking into consideration the properties, behavior and complex relationships of the application domain entities. In addition, the database should be able to sustain seamless spatio-temporal queries and act as a data server to the urban transportation forecasting and micro-simulation models. The database should also permit the result sets display and visualization.

To achieve this objective, the time-geography was used as a framework to analyze the application domain. The object-oriented paradigm served to design the data model, which was implemented into a database prototype hosted by Smallworld GIS™. The prototype was populated with sample data sets drawn from three sources. The first is the Québec region Origin-Destination (O-D) survey conducted in 1991 by the STCUQ (Quebec Urban Community Transit Authority). The second source is the activity places located using Statistics Canada's Postal Code Conversion Files (PCCF). The third source is the Québec region non-planar streets network.

Temporal and positional query extensions were designed and developed to sustain spatio-temporal queries and queries addressed to the space-time path. A Visual Basic™ based interface was designed and implemented in order to facilitate data display and cartographic animation.

The proof-of-the-concept prototype behavior meets the project specifications. The study results contribute to the activity-based travel behavior multidimensional modeling. They enhance approaches that efficiently attempt to integrate space and time through the operationalizing of the time geography main concepts.

The study conceptual and geo-computing findings can be enhanced by researches like temporal and standard query engine integration, cartographic animation, scripting language and intelligent spatial agents. The results can also be easily applied to other domains such as health geography, biography, archeology, land use, cadastral system, forestry and urban planning.

**Keywords:**

Spatio-temporal modeling, object-oriented modeling, spatio-temporal database, spatio-temporal query, temporal-positional query, space-time path, activity-based travel behavior, cartographic animation.



## Table des matières

Résumé.....	iii
Abstract.....	vi
Table des matières.....	viii
Liste des tableaux.....	x
Liste des figures.....	xi
Remerciements.....	xiii
Introduction générale.....	1
Références.....	15
<b>Chapitre I - Spatio-Temporal Object-Oriented Data Model for Disaggregate Travel Behavior</b> .....	<b>23</b>
Abstract.....	24
Introduction.....	25
The Activity-Based Travel Behavior Modeling and GIS.....	26
State of the art.....	26
Study Objective.....	30
A Data Model for Activity-Based Travel Behavior.....	31
Modeling Urban Transportation System Elements.....	31
Designing a Data Model for ABTB.....	33
Our Spatio-Temporal Object-Oriented Data Model and Database Prototype.....	38
Discussion.....	43
Conclusions.....	45
Acknowledgments.....	48
References.....	49
<b>Chapitre II- Querying Travel Behavior Time Paths: Bringing Life into a Static GIS</b> .....	<b>59</b>
Abstract.....	60
Introduction.....	61
Methodology.....	67
Identification and modeling of events, activity events and trip events.....	69
Modeling the time path chains.....	71
Implementing time data structures.....	72
Modeling and implementing the temporal query extension.....	74
Allen's temporal predicates.....	74
Event chain query operators.....	75
Results.....	80
Allen's temporal predicate examples.....	80
Event chain query examples.....	81
Trip object querying involving positional operators.....	81
Person object querying involving positional operators.....	82
Query with reference to trip mode involving positional and attribute operators.....	83
Depiction of a person space-time path.....	84
Conclusion.....	85
Acknowledgements.....	89
References.....	90

Chapitre III- Q&V: An Experimental Interface to Query and Visualize Activity-Based Travel Behavior Data .....	94
Abstract .....	95
Introduction .....	96
Brief state of the art in cartographic animation.....	102
Methodology .....	103
Symbol set and animation procedures development.....	103
Graphical interface development .....	106
Results .....	109
Querying the activity object.....	109
Querying the person object .....	110
Group query .....	111
Individual query .....	112
Discussion .....	115
Conclusion .....	117
Acknowledgments.....	119
References .....	120
Conclusion générale .....	124
Références .....	132

**Liste des tableaux****Chapitre II**

Table 1. Temporal predicates

Table 2. Implemented position methods

Table 3. Implemented time path position methods

Table 4. Set of utility methods

**Chapitre III**

Table 1. Style allocation matrix

## Liste des figures

### Chapitre I

Figure 1. System object diagram

Figure 2. Collaboration diagram with samples of interactions between Person, Trip and Activity objects

Figure 3. Illustration of the database prototype behavior

### Chapitre II

Figure 1. Database collaboration diagram

Figure 2. Activity event chain

Figure 3. Move (Trip) event chain

Figure 4. Time path event chain

Figure 5. Temporal relationships

Figure 6. Examples of position functions on an activity event chain

Figure 7. Examples of time path event position functions

Figure 8. Allen's meets predicate fired as a method by the activity object

Figure 9. Allen's overlaps predicate fired from the person object level

Figure 10. Trip previous activity query sequence diagram

Figure 11. Person activity next trip sequence diagram

Figure 12. Person activity before trip mode sequence diagram

Figure 13. A person time path

Figure 14. Space depiction of a day behavior

### Chapitre III

Figure 1. Illustration of the space-time path (courtesy of Chrisman, 1998)

Figure 2. ABTB object diagram

Figure 3. Activity-based events: (a) Activity-Trip chaining (A-Activity, M-Trip), (b) Activity or Trip positioning, (c) Time-path positioning

Figure 4. Work (T) activities in the activity place “G1V2L8” during the period between 08:00:00 and 20:00:00

Figure 5. The trip that immediately follows the activity 33

Figure 6. Shopping activity (M) performed by female people having an age greater than 65

Figure 7. Places visited by female people having an age greater than 65

Figure 8. Trips meeting the time stamp = 09:33:00

Figure 9. The first trip of the current individual

Figure 10. Activities performed by the current individual

Figure 11. The third trip after the second activity performed by the current individual

Figure 12. The third activity performed just before the fourth trip

Figure 13. The activities performed by the current individual before 18:00:00

Figure 14. Time path of the current individual

Figure 15. Space-time path of the current individual

## Remerciements

Je tiens à remercier :

- Ma directrice de thèse, Danielle J. Marceau, pour la confiance qu'elle m'a témoignée en m'acceptant comme candidat au doctorat, pour sa patience, pour sa disponibilité, pour son dévouement, pour son soutien financier et moral et pour ses judicieux conseils académiques;
- Mon co-directeur de recherche, Marius Thériault, pour la confiance qu'il m'a témoignée en m'acceptant comme candidat au doctorat, pour sa patience, pour sa disponibilité, pour son dévouement, pour son soutien financier et moral et pour ses judicieux conseils académiques;
- Ma femme, Rim, pour avoir accepté que j'embarque dans cette entreprise, pour les sacrifices qu'elle a consentis et pour le soutien moral et affectif qu'elle m'a prodigué;
- Mes enfants, Hédi et Yacin, pour avoir supporté mon absence et pour avoir accepté de reporter nos heures de jeu et d'amusement;
- Le CRNSG pour le soutien financier;
- Le réseau GÉOIDE pour le soutien financier;
- La Communauté urbaine de Québec pour avoir fourni les données de la recherche;
- La Commission de transport de Québec pour avoir fourni les données de la recherche.

Je dédie cette thèse à :

Ma femme Rim

Mes enfants Hédi et Yacin

Mon père ElHajj Abdallah à qui je souhaite un prompt rétablissement

Ma mère Hesna

Ma belle-mère Souad

Ma belle-mère Fatima

Mes frères : Mohammed, Ahmed et Tijani

Mes sœurs : Massouda et Hajer

## Introduction générale

Le système de transport fait partie intégrante du paysage urbain. Sa mission première est de faciliter la mobilité des ressources et l'accès de l'utilisateur aux destinations de son choix. L'étude du système révèle certaines causes de l'état actuel des formes urbaines et permet aussi, à travers la modélisation de la demande, d'interroger le futur, notamment, sur le volume de la demande, sur les changements possibles du comportement et des attitudes des usagers, sur les scénarios de l'évolution de l'utilisation du sol et sur les tendances urbaines émergentes. En fait, l'objectif de la modélisation de la demande en transport est de mettre à la disposition des planificateurs une information fiable et plausible afin de les aider à prendre des décisions de manière plus éclairée. Comme toute discipline scientifique, cette modélisation est traversée par différentes approches dont l'utilisation dépend de l'adaptation des outils d'analyse aux conditions politiques, économiques, sociales et culturelles de l'objet d'étude.

Ainsi, l'approche agrégée (encapsulée dans le corpus de logiciels nommé Système de Planification de Transport Urbain, *Urban Transportation Planning System, UTPS*), est largement adoptée depuis les années 1960. Elle se compose de quatre étapes exécutées séquentiellement : 1) la prédiction de déplacements produits ou attirés par chacune des zones pré-définies des lieux d'activités, 2) la prédiction des flux de déplacements entre ces zones, 3) la prédiction du taux des déplacements par mode de transport sur le réseau routier et 4) l'assignation des déplacements sur le réseau



routier par mode de transport (Dial, 1976; Dickey, 1983; Meyer, 1984). La prédiction se fait sur la base d'une enquête origine-destination (O-D) qui recueille les données de déplacements auprès des ménages. L'enquête O-D est parfois précédée par une analyse de l'utilisation du sol afin d'estimer la croissance de la population et l'état de l'économie. Axés sur le déplacement comme unité d'analyse, les modèles d'estimation sont calibrés et agrégés à une échelle zonale.

En dépit de sa modularité et de sa facilité d'utilisation, cette approche prête le flanc à des critiques à partir des années 1970. Celles-ci se concentrent essentiellement sur le fait que les caractéristiques comportementales individuelles sont noyées dans l'agrégation par ménage et par zone. De ces critiques émergent deux catégories d'approches dites désagrégées qui expliquent le déplacement par le comportement et privilégient le processus décisionnel et cognitif individuel ainsi que le choix négocié dans le cadre d'un ménage. Une de ces approches continue à voir dans le simple déplacement l'élément central pour la prévision de la demande et ce, sans considérer l'interdépendance et l'enchaînement de l'ensemble des déplacements effectués (Stopher and Lisco, 1970). Une autre approche, en réaction à la précédente, aborde la modélisation sous l'angle de l'activité (Golob and Golob, 1982; Ettema and Timmermans, 1999). Cette approche, qui est basée sur l'activité, se définit comme suit :

- (1) Le déplacement est une demande dérivée du besoin des individus et leur prédisposition à participer à différentes activités en différents lieux.

- (2) Le besoin primaire de participer à une activité dépend des circonstances, des préférences et des obligations de chacun.
- (3) Il faut ainsi concevoir une planification des activités qui doivent être faites dans le cadre des contraintes comme les obligations professionnelles, les considérations institutionnelles, la disponibilité des services du système de transport et les relations interpersonnelles, particulièrement à l'intérieur du ménage.
- (4) La personne choisit un programme d'activités le plus optimal en regard aux contraintes reliées aux désirs des autres membres de son ménage, de la disponibilité des moyens de transport et de son budget temporel (Greaves and Stopher, 1998).

Selon cette approche, le déplacement n'est pas considéré comme unité d'analyse puisque c'est la prédisposition de l'individu à participer à une activité qui l'incite à se déplacer faisant ainsi du déplacement la conséquence d'une décision et non sa cause. En privilégiant l'activité comme élément atomique explicatif de la demande de transport, l'approche prévoit analyser les décisions des individus sous différents angles afin de déterminer la causalité de l'enchaînement et des patrons d'activités (Golob and Golob, 1982).

L'approche désagrégée, qu'elle soit basée sur le déplacement ou sur l'activité, exige une logistique d'enquête nettement plus sophistiquée que celle de l'approche agrégée. En effet, elle requiert des données recueillies auprès d'individus. De plus, les

analystes doivent disposer de données spatiales de qualité sur l'emplacement géographique des lieux des activités, sur la configuration du réseau routier, sur les distances à parcourir et les durées des trajets. De telles exigences accroissent considérablement les coûts des enquêtes et le volume de données à traiter, ce qui soulève le problème du stockage, de la manipulation et du repérage des données. Considérant le grand volume de données, les technologies informatiques, telles que les systèmes de gestion de base de données (SGBD) sont d'emblée candidates pour prendre en charge leur gestion. De leur côté, les données spatiales doivent logiquement être traitées par la technologie des systèmes d'information géographique (SIG). D'ailleurs, les SIG qui sont des SGBD dédiés aux données spatiales peuvent intégrer harmonieusement données spatiales et a-spatiales. La littérature relate quelques expériences où un SIG est utilisé comme technologie hôte à des applications dédiées à l'analyse et la simulation des comportements. On peut citer la modélisation de l'accessibilité (Miller, 1991), la simulation des comportements de magasinage (Makin *et al.*, 1996), la modélisation de l'accessibilité à des services (Miller, 1999; O'Sullivan *et al.*, 2000), la planification des activités (Golledge *et al.*, 1994; Kwan, 1999) ainsi que la prise de décision concernant les déplacements (Kwan, 1998; Kwan and Hong, 1998).

Le mérite de ces expériences est qu'elles ont convaincu les chercheurs et les planificateurs du transport du potentiel d'un SIG dédié au transport. D'ailleurs, l'utilisation de ces logiciels augmente progressivement. En fait, les chercheurs et planificateurs sont prêts à se servir de cet outil. Le véritable défi qui se pose est

plutôt : est-ce que la technologie des SIG est prête pour des tâches complexes comme la modélisation et la planification de la demande désagrégée du transport (Spears and Lakshmanan, 1998) ?

Plusieurs problèmes minent les performances de la génération courante des SIG dédiés au transport. Ces problèmes sont de deux ordres : ils relèvent du cadre conceptuel du domaine du comportement de transport basé sur l'activité et de la technologie des bases de données.

Le système du transport est, par inhérence, un domaine spatio-temporel. C'est le contexte de fusion de contraintes spatio-temporelles qui déterminent la faisabilité des activités. Hägerstrand (1970) et Lenntorp (1978) ont établi les fondations du paradigme de géographie temporelle qui offre un cadre théorique unifié pour l'étude du comportement du transport. Selon ce paradigme, le temps et l'espace sont des ressources rares. Cette rareté constitue une contrainte qui détermine largement les patrons des activités quotidiennes. Les activités sont définies par leur localisation et par leur durée. Le prisme spatio-temporel établit les frontières de l'espace possiblement accessible pour une personne durant une période de temps. Il est déterminé par les localisations physiques où la personne doit se trouver au début et à la fin d'une période, le temps requis pour la participation aux activités et la vitesse avec laquelle la personne se déplace. L'espace accessible peut être représenté par un cône tri-dimensionnel ( $x, y$  pour les coordonnées géographiques et  $z$  pour le temps). Le sommet du cône correspond aux localisations courantes tandis que sa pente est

déterminée par la vitesse. Si à la fin du programme d'activité, le lieu de départ correspond au lieu d'arrivée alors deux cônes d'accessibilité fusionnent pour former un prisme spatio-temporel (Miller, 1991). Une séquence d'activités définit une trajectoire spatio-temporelle. Sur un réseau routier (bi-dimensionnel), la trajectoire est représentée par les nœuds où les activités sont réalisées et par les segments de rue qui ont été empruntés par la personne lors des déplacements pour atteindre les nœuds.

Les applications expérimentales de couplage SIG et modèles de transport reconnaissent le caractère spatio-temporel du domaine et s'inspirent de la géographie temporelle comme c'est le cas dans les études de Miller (1991) et Makin *et al.* (1996). Cependant, ces auteurs ne conçoivent pas un modèle de données spatio-temporelles ni n'offrent des outils pour interroger la dimension temporelle enchâssée dans l'enchaînement des activités. Une des causes réside essentiellement dans les SIG coquilles hôtes des applications. Statiques et a-temporelles, ces coquilles ont en fait hérité de la cartographie traditionnelle avec l'obligation de fixer le temps comme le stipule Sinton (1978).

Pour combler cette lacune, des chercheurs ont proposé des modèles spatio-temporels. Ces modèles appartiennent à deux catégories :

- (1) les modèles basés sur les instantanés (snapshots) comme le modèle temporel spatial-composite (Langran and Chrisman, 1988), le modèle d'estampillage temporel simple (Hunter and Williamson, 1990), le modèle d'événements

(Peuquet and Duan, 1995). Ces modèles ne représentent pas les changements entre les instantanés et n'offrent pas d'outils de requêtage spatio-temporel;

(2) les modèles qui représentent le processus de changement à travers l'historique des événements comme le modèle de graphe historique (Renolen 2000), le modèle de trois domaines de Yuan (1994) et le modèle de processus spatio-temporel (Claramunt and Thériault, 1996; Claramunt *et al.*, 1997, 1998; Thériault and Claramunt, 1999; Thériault *et al.*, 1999; Hornsby *et al.*, 1999; Claramunt and Jiang, 2000; Jomier *et al.*, 2000; Panopoulos and Kavouras, 2000; Hornsby and Egenhofer, 2000; Chen and Jiang, 2000). Ces modèles offrent des outils de requêtage spatio-temporel.

(3) Les modèles de représentation des points en déplacement dans l'espace "moving points" (Güting *et al.*, 2000).

Toutefois, ces exemples de modèles restent d'une utilité réduite pour le domaine de comportement du transport basé sur l'activité puisqu'ils représentent la dynamique des phénomènes naturels dénotée par un changement de l'extension spatiale, la représentation des primitives de processus spatiaux et aux changements de position dans l'espace. La modélisation centrée sur l'activité, de son côté, réfère surtout aux séquences de déplacement. Néanmoins, la littérature mentionne deux applications destinées à la modélisation centrée sur l'activité. Thériault *et al.* (1998) utilisent la coquille d'un SIG relationnel pour développer une application de simulation de choix de route. L'application montre deux faiblesses majeures caractéristiques du modèle relationnel. Pour repérer des données spatio-temporelles, des requêtes complexes

doivent être formulées et codées par un usager expert en langage SQL (Structured Query Language). De plus, le moteur de requête relationnel qui traite ces requêtes réclame un temps inacceptablement long de recherche et de repérage de données. L'application de Wang and Chang (2001) consacrée au comportement de déplacement basé sur l'activité devrait montrer les mêmes faiblesses puisqu'elle est aussi hébergée par un SIG relationnel.

Autant pour les applications expérimentales de couplage SIG et modèles de transport que pour les SIG commerciaux dédiés au transport, la gestion des données suit les normes plus ou moins standards du modèle relationnel. Même si ce modèle assure une cohérence et une intégrité de la base de données, il ampute le domaine d'application de sa sémantique propre en imposant des structures de représentation étrangères au domaine. Ainsi, les entités qui, dans le monde réel, sont hiérarchiquement construites et entretiennent des liens sémantiques significatifs doivent être fragmentées en tables et reliées par des relations artificielles (Joseph *et al.*, 1991; Kemp and Kowalczyk, 1994; Mattos *et al.*, 1993; Wiegand and Adams, 1994; Karimi and Lee, 1995; Scarponcini, 1995). D'autre part, ces entités agissent sur le monde environnant et réagissent à ses stimulus par des comportements que le modèle relationnel omet de considérer. À titre d'exemple, une personne possède des attributs comme le nom, l'âge et la profession, mais aussi des facultés cognitives qui lui permettent de choisir ses activités et l'itinéraire de son déplacement. Avec le modèle relationnel, cette entité est représentée par une table comportant ses attributs.

Le comportement cognitif, l'attitude et l'éventail des actions et réactions possibles qui la caractérisent sont tout simplement ignorés.

Il existe d'autres méthodologies de modélisation de données qui rendent compte de la richesse sémantique comme la méthodologie relationnelle étendue, la méthodologie entité-relation étendue (Parent *et al.*, 1997; Renolen, 2000; Wang and Cheng, 2001) et le paradigme orienté-objet (Coad and Yourdon, 1990; Blaha and Premerlani, 1998; Booch, 1999).

Ce qui distingue le paradigme orienté-objet est qu'il opérationnalise la métaphore de l'objet et qu'il permet une représentation des entités du domaine d'application d'une manière similaire à la perception humaine du monde. Les entités sont représentées par des objets qui possèdent à la fois des attributs identitaires et des comportements. Ils s'associent par simple relation ou par hiérarchie (agrégation et héritage). À l'aide de ces concepts axés sur la sémantique, l'approche orientée-objet reproduit plus fidèlement la complexité du monde réel. En outre, le paradigme orienté-objet propose un cadre intégré de développement d'application qui englobe toutes les étapes du cycle de développement allant de la conception jusqu'au déploiement et ce, avec des pertes sémantiques minimales. D'ailleurs, l'adoption de ce paradigme par les chercheurs n'est pas loin de faire l'unanimité si l'on se réfère aux écrits de Raper and Levingstone (1995), Newell (1992), Milne *et al.* (1993) Egenhofer and Frank (1992), Wiegand and Adams (1994), Kemp and Kowalczyk (1994), Bédard (1999), Worboys



(1990), Worboys *et al.* (1990), Worboys (1994), Worboys (1999) et Makin *et al.* (1997).

Notre étude fait partie d'un vaste programme multidisciplinaire de recherche en modélisation de transport dont les buts sont :

- (1) reproduire le comportement de déplacements des individus et des ménages
- (2) étudier les relations entre les décisions de déplacements prises localement et les tendances urbaines globales
- (3) détecter, tracer et classifier la dynamique des trajectoires spatio-temporelles des individus et des groupes
- (4) fournir de l'aide à la planification du transport urbain
- (5) étudier les impacts de l'implantation de services et du changement de l'offre de transport sur le système urbain, ainsi que ses possibles évolutions et ses éventuels états futurs.

Plus spécifiquement, l'objectif de notre étude est de concevoir et d'implanter une base de données spatio-temporelle de comportement de transport basé sur l'activité. Elle doit être en mesure de modéliser le comportement désagrégé de transport avec un minimum de perte sémantique et ce, par la modélisation des propriétés et du comportement des entités spatio-temporelles et par la modélisation des relations simples et complexes tissées entre les entités. Cette base de données doit aussi gérer facilement les requêtes spatio-temporelles (Peuquet, 1994; Yuan, 1994; Lee and Kemp, 1998) et permettre l'affichage et la visualisation des ensembles sélectionnés.

Elle doit devenir un serveur de données qui fournit une infrastructure aux modèles de prévision et de simulation du transport urbain.

Pour les besoins de cette recherche, nous disposons de données provenant de trois sources. La première est une enquête origine-destination (O-D) réalisée en 1991 dans la région de Québec, au Canada, par la Société de transport de la Communauté urbaine de Québec (STCUQ) comportant plus de 110 000 enregistrements. La seconde source est la localisation des lieux d'activités selon le système de conversion des codes postaux de Statistiques Canada. La troisième est le réseau routier de la ville de Québec. Le SIG retenu pour le développement de la base de données est Smallworld GIS™, version 3.1, produit et commercialisé par la firme GE Smallworld™.

Nous avons établi les suppositions suivantes :

- (1) Le cadre de la géographie temporelle est le cadre théorique qui offre le plus de richesse conceptuelle à la modélisation du comportement de transport basé sur l'activité. Nous concevons le comportement de transport basé sur l'activité comme un contexte transactionnel où la personne échange un actif temporel contre l'occupation d'un espace. L'historique de ces transactions est la matière première qu'il faut analyser afin de comprendre le présent, expliquer le passé et prévoir le futur.
- (2) Le comportement de transport basé sur l'activité est un domaine doté d'une sémantique complexe et riche. Pour rendre compte de cette sémantique, le

paradigme orienté-objet offre la méthodologie la plus souhaitable pour la modélisation conceptuelle spatio-temporelle et pour l'implantation physique du schéma de la base de données.

- (3) L'usage de la technologie des bases de données temporelles (Snodgrass, 2000) est une condition nécessaire mais non suffisante pour transformer une base de données statique de comportement de déplacement basé sur l'activité en une base de données temporelle puisque l'unité d'analyse n'est pas l'enregistrement mais la trajectoire spatio-temporelle.
- (4) La trajectoire spatio-temporelle est une entité distincte. Sa structure est dépendante de l'agencement des événements (les activités et les déplacements). Cet agencement enchâsse la topologie temporelle des événements et détermine les fonctions de repérage et d'accès à ces événements.
- (5) Sans moteur de requêtes temporelles, spatio-temporelles et événementielles, la base de données serait incapable de fournir des ensembles de données spatio-temporelles aux modèles de simulation.
- (6) La stratégie de prototypage est la plus appropriée pour le développement de la base de données. Son approche incrémentale, associée au paradigme orienté-objet permet le développement rapide de l'application tout en facilitant la modification et la maintenance.

La méthodologie que nous avons choisie afin de réaliser ce projet se subdivise en trois étapes qui font respectivement l'objet des trois prochains chapitres:

- (1) la première étape consiste en l'analyse du domaine du comportement de transport basé sur l'activité pour l'identification de sa sémantique et de ses composantes significatives, le développement d'un modèle orienté-objet spatio-temporel et son implantation dans un prototype de base de données hébergé par la coquille Smallworld GIS™.
- (2) durant la seconde étape, les structures temporelles nécessaires pour transformer le prototype en un prototype temporel sont implantées. De plus, nous avons développé un requêteur temporel inspiré par Allen (1984) et un requêteur positionnel topologique des enchaînements des activités, des déplacements et de la trajectoire temporelle des individus. Ces requêteurs permettent au prototype de gérer les requêtes spatio-temporelles.
- (3) la troisième étape est consacrée à la création d'une interface graphique conviviale basée sur Visual Basic™. Cette interface joue deux rôles:
  - a) elle remplace l'interface textuelle de prototype dont l'utilisation demande une connaissance approfondie du langage Smallworld Magik. En fait, elle offre à l'utilisateur la possibilité de formuler des requêtes spatio-temporelles à l'aide de l'approche pointer-sélectionner. Les résultats des requêtes sont automatiquement affichés dans un format tabulaire.
  - b) elle permet d'activer les routines automatisant le traçage dynamique de la trajectoire spatio-temporelle des individus suivant une approche d'animation cartographique et le choix de symboles et de couleurs de

points et des lignes selon le mode et le motif du déplacement et le type d'activité.

Les trois prochains chapitres feront respectivement l'objet de trois publications. Le premier chapitre est sous presse dans la revue *Transactions in GIS*. Le second chapitre a été soumis à la revue *Geoinformatica*. Le troisième chapitre sera soumis à la revue *Cartography and GIS*.

## Références

- Allen, J. F. 1984 Towards a general theory of action and time. *Artificial Intelligence* 23:123-154
- Bédard Y. 1999 Principles of spatial databases analysis and design. In Longley P A, Goodchild M F, Maguire D J and Rhind D W (eds) *Geographical Information Systems*. New York, John Wileys and Sons: 413-424
- Blaha M. and Premerlani W. 1998 *Object-oriented modeling and design for database applications*. New Jersey, Benjamin/Cummings
- Booch G. 1999 *Object-oriented analysis and design with applications* (Second Edition). Reading, MA, Addison-Wesley
- Chen J. and Jiang J. 2000 An Event-based Approach to Spatio-Temporal Data Modeling in Land Subdivision Systems. *Geoinformatica*, 4:387-402
- Claramunt C. and Jiang B. 2000 Hierarchical Reasoning in Time and Space. In Forer P, Yeh A and He J (eds.) *Spatial Data Handling 2000*, Beijing, China.
- Claramunt C., Parent C. and Thériault M. 1997 Design patterns for spatio-temporal processes. In Spaccapietra S and Maryansky F (eds) *Data mining and reverse engineering*. London, Chapman & Hall: 455-475
- Claramunt C., Thériault M. and Parent C. 1998 A qualitative representation of evolving spatial entities in two-dimensional topological space. In Carver S (editor) *Innovations in GIS*. London, Taylor & Francis:128-139
- Claramunt C. and Thériault M. 1996 Toward semantics for modeling spatio-temporal processes within GIS. In Kraak M J and Molenaar M(eds) *Proceedings of the 7th*

- International symposium on Spatial Data Handling*. Thijsseweg, Delft University of Technology, Faculty of Geodetic Engineering:2.27-2.43
- Coad P. and Yourdon E. 1990 *Object oriented analysis*. New Jersey, Yourdon Press
- Dial R. B. 1976 Urban transportation planning system: philosophy and function. *Transportation Research Record* **599**:60-64
- Dickey J. W. 1983 *Metropolitan transportation planning*. New York, Hemisphere Publishing Company
- Egenhofer M. J. and Frank A. U. 1992 Object-oriented modeling for GIS. *Urban and Regional Information Systems Association Journal* **4**:3-19
- Ettema D. and Timmermans H. 1999 Theories and models of activity patterns. In Ettema D and Timmermans H (eds) *Activity based approaches to travel analysis*. UK, Elsevier Science ltd: 1-35
- Golledge R. G., Kwan M. P. and Garling T. 1994 Computational process modeling of household travel decisions using a geographical information system. *Papers in regional science* **73**:99-117
- Golob J. M. and Golob T. F. 1982 Classification of approaches to travel-behavior analysis. *Transportation Research Board, Special Report* **201**: 83-127
- Greaves S. and Stopher P. 1998 A synthesis of GIS and activity-based travel forecasting. *Geographical Systems* **5**:59-89
- Güting R. H., Böhlen M. H., Erwing M., Jensen C. S., Lorentzos N. A., Shneider M. and Vazirgiannis M. 2000 Foundation for Representing and Querying Moving Objects. Online <http://www.dbnet.ece.ntua.gr/~choros/>

- Hägerstrand T. 1970 What about people in regional science? *Papers of the Regional Science Association* **4**:7-21
- Honsby K., Egenhofer M. J. and Hayes P. 1999 Modeling Cyclic Change. In Chen P, Embly D, Koulondjan J, Liddle S and Reddinck J (eds) *Advances in Conceptual Modelling*. Edinburgh, Springer-Verlag, Lecture Notes in Computer Sciences **1227**:98-109
- Hornsby K. and Egenhofer M. J. 2000 Identity-based Change: A Foundation for Spatio-temporal Knowledge representation. *International Journal of Geographical Information Science* **14**:207-224
- Hunter G. J. and Williamson I. P. 1990 The development of a historical digital cadastral database. *International Journal of Geographical Information Science* **4**:169-179
- Jomier G., Peerbocus M. A. and Huntzinger J. B. 2000 Visualizing the Evolution of Spatiotemporal Objects. In Forer P, Yeh A and He J (eds.) *Spatial Data Handling 2000*, Beijing, China, 7a: 13-25
- Joseph V. J., Thatte S. M., Thompson C. W. and Wells D. L. 1991 Object-oriented databases : Design and implementation. In *Proceedings of the IEEE 1991*. Los Alamitos, IEEE Computer Society Press: 42-64
- Karimi H. A. and Lee Y. C. 1995 Semantic data models in GISs and object orientation. In *The Ninth annual symposium on geographic information systems*. Fort Collins, GIS World Inc.:407-412
- Kemp Z. and Kowalczyk A. 1994 Incorporating the temporal dimension in a GIS. In Worboys, M. F. (editor) *Innovations in GIS*. London, Taylor & Francis:89-103



- Kwan M. 1998 Space-time and integral measures of individual accessibility: A comparative analysis using a point-based framework. *Geographical Analysis* **30**:191-216
- Kwan M. 1999 Gisas: An activity-based travel decision support system using a GIS interfaced computational-process model. In Ettema D. and Timmermans H. (eds) *Activity based approaches to travel analysis*. UK, Elsevier Science Ltd: 263-282
- Kwan M. and Hong X. 1998 Network based constraints oriented choice set formation using GIS. *Geographical Systems* **5**:139-162
- Langran G. and Chrisman R. 1988 A framework for temporal geographic information. *Cartographica* **25**:1-14
- Lee H. and Kemp Z. 1998 Supporting complex spatiotemporal analysis in GIS. In Carver S (editor) *Innovations in GIS*. London, Taylor & Francis:151-161
- Lenntorp B. 1978 A time-geographical simulation of activity programs. In Carlstein T, Parkes D and Thrift N (eds) *Timing Space and Spacing Time, Volume 2: Human Activity and Time Geography*. London, Edward Arnold Ltd:162-180
- Makin J., Healey R. G. and Dowers S. 1996 Simulation modelling with object-oriented GIS: a prototype application to time geography of shopping behavior. *Geographical Systems* **4**:397-429
- Mattos N. M., Meyer-Wegener K. and Mitschang B. 1993 Grand tour of concepts of object-orientation from a database point of view. *Data & Knowledge Engineering* **9**:321-352
- Meyer M. D. and Miller E. J. 1984 *Urban transportation planning: a decision oriented approach*. New York, McGraw-Hill

- Miller H. J. 1991 Modelling accessibility using space-time prism concepts within geographical information systems. *International Journal of Geographical Information Science* **5**:287-301
- Miller H. J. 1999 Measuring space-time accessibility benefits within transportation networks: Basic theory and computational procedures. *Geographical Analysis* **31**:187-212
- Milne P., Milton S. and Smith J. L. 1993 Geographical object-oriented databases: a case study. *International Journal of Geographical Information Science* **7**:39-55
- Newell R. G. 1992 Practical experiences of using object-orientation to implement a GIS. In *Proceedings of the GIS/LIS*. Bethesda, American Society for Photogrammetry and Remote Sensing:624-629
- O'Sullivan D., Morrisson A. and Shearer J. 2000 Using desktop GIS for the investigation of accessibility by public transport: an isochrone approach. *International Journal of Geographical Information Science* **14**:85-104
- Panopoulos G. and Kavouras M. 2000 Spatio-temporal Modelling: incorporating the Concept of Change in Socio-Economical Applications. In *Proceedings of the Third Agile Conference of Geographic Information Science*, Helsinki, Finland:205-208
- Parent C., Spaccapietra S., Zimanyi E., Donini P., Plazanet C., Vangenot C., Rognon N. and Crausaz P. A. 1997 MADS, modèle conceptuel spatio-temporel. *Revue Internationale de Géomatique* **7**:317-352

- Peuquet D. and Duan N. 1995 An event-based spatio-temporal data model (ESTDM) for temporal analysis of geographic data. *International Journal of Geographical Information Science* **9**:7-24
- Raper J. and Livingstone D. 1995 Development of geomorphological spatial model using object-oriented analysis. *International Journal of Geographical Information Science* **9**:359-383
- Renolen A. 2000 Modelling the real world: Conceptual modelling in spatiotemporal information system design. *Transactions in GIS* **4**:23-42
- Scarponcini P. 1995 Object-oriented vs. relational database management systems for GIS. In *Proceedings of Urban and Regional Information Systems Association 1995*: 445-461
- Sinton D. F. 1978 The Inherent Structure of Information as a Constraint to Analysis: Mapped Thematic Data as a Case Study. In G.H. Dutton (Ed.), *Harvard Papers on Geographic Information Systems*, Vol. 7, Reading, Massachusetts: Addison-Wesley.
- Snodgrass R. T. 2000 *Developing time-oriented database application in SQL*. San Francisco, Morgan Kaufman Publishers.
- Spear B. D. and Lakshmanan T. R. 1998 The role of GIS in transportation planning and analysis. *Geographical Systems* **5**:45-58
- Stopher P. R. and Lisco T. E. 1970 Modelling travel demand: Disaggregate behavioral approach, issues and applications. *Transportation Research Forum* :195-214

- Thériault M., Leroux D., and Vandersmissen M. H. 1998 Modelling travel route and time within GIS: its use for planning. In Bergelia A., Kerckhoffs E. (ed.) *The 10th European Simulation Symposium (October 26-28, 1998)*. Delft, Society for Computer Simulation International: 402-407
- Thériault M. and Claramunt C. 1999 La représentation du temps and des processus dans les SIG: Une nécessité pour la recherche interdisciplinaire. *Revue Internationale de Géomatique* **9**:67-99
- Wang D. and Cheng T. 2001 A spatio-temporal data model for activity-based transport modeling. *International Journal of Geographical Information Science* **15**:561-585
- Wiegand N. and Adams T. M. 1994 Using object-oriented database management for feature-based GIS. *Urban and Regional Information Systems Association Journal* **6**:21-36
- Worboys M. F. 1994 Object-oriented approaches to geo-referenced information. *International Journal of Geographical Information Science* **8**:385-399
- Worboys M. F., Hearnshaw H. M. and Maguire D. J. 1990 Object-oriented data modeling for spatial databases. *International Journal of Geographical Information Science* **4**:369-383
- Worboys M. F. 1999 *Relational databases and beyond*. In Longley P A, Goodchild M F, Maguire D J, Rhind D W, (eds) *Geographical Information Systems*. New York, John Wileys and Sons:373-384

Yuan M. 1994 Wildfire conceptual modeling for building GIS space-time models. In *Proceedings of GIS/LIS 1994*. Bethesda, American Society for Photogrammetry and Remote Sensing: 860-869

Le premier chapitre expose le cadre théorique et la méthodologie utilisés pour la modélisation du domaine du comportement de transport basé sur l'activité ainsi que l'implantation d'une base de données dans un prototype hébergé par une coquille SIG statique.

# Chapitre I - Spatio-Temporal Object-Oriented Data Model for Disaggregate Travel Behavior

Ali Frihida\*



Danielle J. Marceau\*



Marius Thériault\*\*



\*Geo-Computing Laboratory, Département de Géographie, Université de Montréal

\*\*Centre de Recherche en Aménagement et Développement, Université Laval

**Keywords :** Disaggregate travel behavior modeling, spatio-temporal databases,  
object-oriented modeling, Smallworld GIS.

Cet article est sous presse dans la revue *Transactions In GIS*

**Abstract**

The research field of transportation demand forecasting is actually focusing on disaggregate travel behavior and micro-simulation models. To create data infrastructure, disaggregate trip surveys are conducted and huge quantity of observations are collected. To efficiently exploit these surveys, organizing the individual trip data into a geographic information system (GIS) must start with building a solid conceptual data model that fully captures the semantic richness of the application domain, and emphasizes its spatio-temporal properties. This paper presents a data modeling process that is based on a combination of complex system theory and the object-oriented paradigm and produced an object-oriented spatio-temporal data model. Main domain entities are modeled as highly structured classes. They encapsulate a memory of their time bound connections and states. Observation data sets are sampled from the origin-destination survey conducted in the Québec region in 1991, including activity places and street network. The model was smoothly implemented into a proof-of-concept database prototype hosted by an object-oriented GIS shell. The prototype offers a means to navigate through a nested hierarchy of objects, providing a description of an individual's travel behavior over space and time. The objects have a solid ground to meet the needs of the scientific research such as hypothesis formulation, simulation, forecasting and induction.



## **Introduction**

Enhancing transportation demand forecasting needs better understanding of disaggregate travel behavior and development of comprehensive micro-simulation models. In many regions, surveys are conducted to accumulate large numbers of trip descriptions, combining GPS vehicle tracking, one-day origin-destination (OD) surveys, real-time vehicle movement monitoring and longer term panel surveys. These data collection activities provide huge data sets, which must be analyzed considering both geographical and temporal constraints. Such analyses are needed to understand interactions between the observed trips and the urban environment where they take place. GIS technology can efficiently exploit these data, making appropriate spatial links between individual trips, transportation networks, and the distribution of activity places in the region. However, to unleash all its analytical potential, this integration must start with the development of a solid conceptual data model that fully captures the semantic richness of the application domain, and emphasizes its spatio-temporal properties.

The main principle behind transportation behavior modeling relies on the fact that most people try to optimize their satisfaction while they are constrained by their household, agenda and living places. The design of a GIS for assessing the variation of individual travel demand in the context of the urban planning is the main topic of this research. It is a challenging task since the micro-scale (individual) dynamic

nature of the application field requires a GIS that sustains spatio-temporal queries with a data structure constrained by micro-simulation needs.

This paper is divided into four sections. The advantages of the disaggregate travel behavior approach in comparison with the aggregate zonal trip approach, coupling of GIS and transportation models, and the project objective are discussed in section 1. The urban transportation system (UTS) is characterized as a complex system, and the data representation issues are exposed in terms of the object-oriented modeling paradigm in section 2. A new object-oriented data model and the proof-of-concept database prototype that was developed to evaluate its performance are portrayed in section 3. The final section describes some observations about the project to date and presents work in progress.

## **The Activity-Based Travel Behavior Modeling and GIS**

### **State of the art**

The aggregate zonal trip forecasting approach refers to a standard sequence of stages that includes: (1) trip generation (prediction of trips produced and attracted by each of the designated traffic analysis zones), (2) trip distribution (prediction of origin-destination (O-D) flows), (3) modal split (prediction of the rate of O-D flows by available transportation modes), and (4) trip assignment (setting of O-D flows by modes on the road network). These stages are sometimes initiated by a land-use analysis in order to estimate population and economic growth. This approach, embedded in urban transportation planning system forecasting models (UTPS), has

gained large acceptance and has been used to guide transportation plans and investments since the 1960s (Dial 1976, Dickey 1983, Meyer 1984).

Meanwhile, the operational context of the transportation system has considerably changed and interest in another approach, activity-based travel behavior modeling (ABTB), has developed. This approach is more adapted to emerging social and urban trends, such as nuclear and single parent families, urban sprawl, the rising number of personal vehicles, the information-based economy, globalization, tele-commuting, and environmental concerns. ABTB copes with the current political tendency towards non-capital investment, optimization of the use of existing assets, individual travel behavior modification, and local-scale planning and decision-making. It focuses on the detailed level of household/individual activities. ABTB modeling incorporates several assumptions ignored by the UTPS approach, such as the cognitive choice process of each individual, his/her participation in activities occurring at different locations and times, and the importance of the household member's interactions, individual preferences, obligations, perceptions and choices in the trip decision-making (Greaves and Stopher 1998). It is composed of a large corpus of disaggregate (micro-simulation) models which have their pedigree rooted in the Hägerstrand spatio-temporal prism (Hägerstrand 1970, Lenntorp 1978), economics, cognitive science, and in transportation discrete choice models (see Stopher and Lisco (1970), Golob and Golob (1982) and Ettema and Timmermans (1999) for extensive reviews of these models).

Therefore, several researchers are focusing on the disaggregate level (individual or household) to characterize the intricacies of urban transportation patterns with the assumption that macro changes are resulting from a myriad of complex and subtle interactions between fine scale individual choices. A huge quantity of data is collected during individual trip surveys as a first step to constitute a data infrastructure for enabling analysis of the low-level processes and building micro-simulation multi-agent systems.

Because the ABTB approach is explicitly interested in event time sequences of individual/household trips within a delimited space (road network and activity places), GIS should constitute a suitable integrative technology even though transportation demand modeling and GIS technology share parallel trajectory histories (Spear and Lakshmanan 1998). In a pioneer requirement analysis study for computing space-time accessibility using GIS, Miller (1991) demonstrates the potential gains of coupling GIS and ABTB. Since, the literature provides many examples of GIS-ABTB applications including the implementation of activity-based forecasting models (McNally 1998), simulation of shopping behavior (Makin et al. 1996), modeling facilities accessibility (Miller 1999a, O'Sullivan et al. 2000), modeling activity-scheduling (Golledge et al. 1994, Kwan, 1999), travel decision-making (Kwan 1998, Kwan and Hong 1998, Kwan 1999), activity patterns (van der Knaap 1999), and mobility sequences (Wang and Cheng 2001). These studies represent important steps for developing operational frameworks to effectively

integrate GIS and the ABTB models (Miller 1998, 1999b, Summers and Southworth 1998).

Although several of these applications demonstrate the benefits of coupling GIS and ABTB models, the above applications have their weaknesses. They are experimental *ad hoc* solutions dedicated to specific problem domains that prohibit their re-use. Furthermore, these applications did not tackle explicitly the spatio-temporal dimension of the ABTB, thus they have minimal or no comprehensive spatio-temporal model. Moreover, many of these applications are developed with the current generation of GIS from which they inherit their static data models devoid of temporal reasoning capabilities. Finally, their data test beds are rarely full survey data sets. Thériault et al. (1998, 1999) developed an application based on the simulation of route choices using an explicit spatio-temporal model, and a real origin-destination data survey. However, their study showed two important drawbacks. First, to retrieve spatio-temporal data sets, long nested SQL queries must be formulated and coded by an expert user. Second, the relational database that manages the spatio-temporal data model requires unacceptable high seek and retrieval times to process the formulated queries using large data sets. Wang and Cheng (2001) developed a spatio-temporal application for activity-based transportation using a relational data model populated with test data collected from six families. Even if the conceptual EER (extended entity-relationship) data model of the application renders most of the semantics of the domain, it is expected that the application will behave in a similar way to that of

Thériault et al. (1998, 1999) application because it is built on the same relational data modeling approach.

### **Study Objective**

Our study is a part of a long-term multidisciplinary transportation project whose goals are:

- (1) replicate individual and household travel behavior as a decision-making cognitive process (unveil reasons behind day-to-day scheduling, activity prioritizing and planning, trip organization, itinerary choices, etc...),
- (2) investigate the relationship between the micro decision about travel and global urban trends,
- (3) detect, depict and classify individual and groups space-time dynamics,
- (4) help with the planning of urban transportation systems, and
- (5) study the way new transportation and communication facilities impact the urban system, describe different and possible evolution trajectories, and forecast possible and different future states.

The research niche of this study is the modeling of individual travel behavior from a geo-computing perspective. The objective is to design and implement a disaggregate travel behavior spatio-temporal database which emphasizes individual behavior. The database is intended to be a data server that provides a spatio-temporal infrastructure to urban and transportation micro-simulation and forecasting models. It should be able to model disaggregate travel behavior with a minimum loss of semantic richness

by: (1) modeling the properties and behavior of the spatio-temporal entities, and (2) modeling simple and complex spatio-temporal relationships between those entities.

The database should sustain seamless spatio-temporal queries (Peuquet 1994, Yuan 1994, Lee and Kemp 1998). According to Sinton (1987), geographical queries are built on a fundamental rule: fix, control and measure. In this way, a spatio-temporal query can be articulated around a combination of time, space and theme where one of these variables is constant, the value of the second is controlled, and the third is the one to be quantified (Yuan 1994).

The database should lay on a generic data model, i.e. independent from specific hardware or software platforms with an open architecture that permits enhancement extensions. Finally, the database should have a convivial user interface with tools such as visual query and cartographic animation tools. In the next section, we discuss the representation issues implied by modeling the ABTB domain of discourse.

## **A Data Model for Activity-Based Travel Behavior**

### **Modeling Urban Transportation System Elements**

Urban transportation systems (UTS) are complex systems. By complexity, we mean there is a large variety of hierarchically organized components that interact with each other over time in a non-linear way to form sub-systems and the whole system. The interactions between components drive changes in the system properties. System

dynamics refers to system changes over time. These changes can occur at a micro-level and have impacts on the system at the macro-level and vice-versa (Ashby 1957, Turchin 1977, De Rosnay 1979, Aerts et al. 1994). An urban transportation system is constantly changing as it adapts to new urban forms and constraints.

As an example, a commuter can be a white or blue collar worker with a specific gender. He or she belongs to social structures, such as household type, family structure, neighborhood activities, and community values, that can have different influences on his or her travel behavior (Vandersmissen et al. 2001). A trip is composed of itineraries. Road segments are not all of the same type: traffic volume, permitted speed and link length vary. The commuter's characteristics are increasing in variety (new family structure, young retirees, telecommuting ...) as are the facilities (shopping centers, leisure facilities), individual and public transportation modes, and the commuting flows on the road network. A road accident can have an immediate and temporary side effect that can be propagated over the whole transportation network. A public transportation planning decision has its cascading effects echoed by the commuter's trip decision-making that can have a long-term impact on the global performance of the UTS.

The complexity qualifier refers to a UTS fundamental property: the *knowledge* of its overall behavior is dependent on the *description* and *representation* of its *atomic subsystems*, *their behavior*, and their *dynamics*. The description/representation implies a focus on a *reduced set* of dimensions taken from the domain under



investigation that is considered sufficient (*abstraction*) for describing the system. This information filtering is determined by the chosen temporal and spatial representation scale (granularity, changes or invariance, more or less details), and chosen level of knowledge accuracy (general or detailed) that is desired.

These assumptions bring to the forefront the critical importance of the intended system data model. In fact, designing a computer-based representation of the UTS domain semantics (components, characteristics, behavior, hierarchy, mutual relationships and changes processes) as a perceived abstraction is a major and challenging task. The reason is that the information loss in the abstraction stage will be increased by another loss that occurs during the translation to the representation formalism of the chosen system development methodology.

### **Designing a Data Model for ABTB**

Thus, if we take the relational data model as a target representation formalism, the ABTB as a complex application domain will lose its semantic richness when forced by the normalization rules to fragment its structured entities into restrictive relations (tables) and relationships (Kemp and Kowalczyk 1994, Karimi and Lee 1995, Wiegand and Adams 1994, Scarponcini 1995). The same deficiency can be observed when the entity relationship (ER) methodology (Chen 1976) is used because it does not offer means for modeling entities behavior even if it can render their highly structured state.

These modeling concerns are behind the research of data models that minimize semantic loss. One research direction is to enhance the relational and ER methodologies by proposing extensions that handle highly structured data types and their behavior. Examples of such efforts are provided by the recent extended ER methodologies (EER) that can build rich semantic data models (Renolen 2000, Wang and Cheng 2001). But the EER are superseded by the potential offered by the object-oriented paradigm (OOP) (Worboys 1999, Renolen 2000).

The main advantage of the OOP is that it permits a more direct intuitive representation of complex real world entities and phenomena in a way that is similar to the human knowledge construction process. The object metaphor permits the mapping of real world entities to a computer system without using out-of-domain entities and relationships between or within entities such as tables and their links constrained by cardinality (Joseph et al. 1991, Newell 1992, Egenhofer and Frank 1992, Wiegand and Adams 1994, Kemp and Kowalczyk 1994, Bédard 1999).

In comparison to the EER that is essentially a data modeling approach, the OOP offers a unified representation approach to the system development cycle (analysis, design, implementation, deployment) (Worboys 1999). Thus, the OOP reduces the *impedance mismatch*. This problem results from the forced translation of scientific models into low-level computational models (data structures and procedures). Furthermore, the lasting negative effects such as a semantically poor data model, system hard and costly modifications, and low system performance are largely

avoided (Joseph et al. 1991, Courtois 1985, Parsey et al. 1989, Coad and Yourdon 1990, Worboys et al. 1990, Mattos et al. 1993, Worboys 1994a, Booch 1999).

Thus, by using the OOP, we have the possibility to build a close-to-reality ABTB data model with enhanced expressive power, adequacy and accuracy (Karimi and Lee 1995, Makin et al. 1997, Golledge 1998). This model should consider the disaggregated travel activity as a time-space domain. Each traveller has a daily time budget that he spends within a planned schedule at different activities locations. Activity choice and planning are dictated by constraints such as activity priorities, entire household needs, available transportation modes, proximity and opening hours of activities locations.

The needed data model should also be able to keep track of, and to trace back ABTB events chaining in a similar way to building a graph of time bound connections and states representing *space-time paths* for individuals. The reasoning tasks for space-time path construction are: *prediction* of future states, *explanation* of past states, *learning new rules* from recurrent facts, and *planning* for still-to-come outcomes (Peuquet 1994, Claramunt and Thériault 1996, Wachowicz 1999, Thériault and Claramunt 1999).

Once physically implemented, the data model should be a core component of a temporal GIS (T-GIS). The development of T-GIS is benefiting from the work of two research groups. The first aims to build a theoretical framework that can help GIS

technology to overcome its lack of temporal reasoning capabilities and become an efficient simulation and forecasting tool. This group has so far produced two kinds of models:

- (1) models that sustain simple spatio-temporal queries. These models, based on snapshot sequences (states separated by time units), do not represent changes between states. We can distinguish the space-time composite model (Langran and Chrisman 1988), the simple time-stamping model (Hunter and Williamson 1990), and the event-oriented model (Peuquet and Duan 1995) in this class;
- (2) models that sustain seamlessly complex spatio-temporal queries. These models represent processes by managing the history of events, states and changes. The history graph model (Renolen 2000), the three domain model (Yuan 1994), the spatio-temporal process model (Claramunt and Thériault 1996, Claramunt et al. 1997, 1998, Thériault and Claramunt 1999, Thériault et al. 1999, Hornsby et al. 1999, Claramunt and Jiang 2000, Jomier et al. 2000, Panopoulos and Kavouras 2000, Hornsby and Egenhofer 2000, Chen and Jiang 2000) are examples of this second class of models.

The second research group is made of GIS and computer scientists whose goal is to extend the scope of the database management systems (DBMS) to efficiently handle space and time during the development cycle (e.g. Al-Taha et al. 1993, Kline 1993, Tsotras and Kumar 1996). The OOP practitioners from this group proposed different OO data models. The Oogeomorph model (Raper and Livingstone 1995) endorses the

use of OOP concepts in geomorphology. Other models that offer generic OO integrative solutions of the temporal and spatial dimensions include the IFO model (Worboys et al. 1990), the OOSTM model (Cheng and Gadia 1992), the STDS model (Milne et al. 1993), the OOST versioning model (Wachowitz and Healey 1994), the SIDL model (Rojas-Vega and Kemp 1995), and the MADS model (Parent et al. 1997). Further details can be found in reviews provided by Abraham and Roddick (1999) and Renolen (2000).

None of these models was intensively tested or is considered as *de facto* standard, and more dedicated OO spatio-temporal data models should be designed and calibrated with representative data sets as a way to validate the promise of OOP. The OOP applied to the spatio-temporal domain will likely establish itself as a standard when a critical mass of developed and positively tested models is generated. Our project is part of this research stream.

Our intention is to design an OO data model for ABTB. Moreover, we will implement it as a database prototype, test it by using samples of disaggregate travel behavior survey data sets, and observe its particularities relative to the validation of the OOP claims. The model and prototype development are described in the following section.

## **Our Spatio-Temporal Object-Oriented Data Model and Database Prototype**

When analyzing the ABTB domain, the Person entity appears as the axial actor. Its role is composed of trip decision-making, activity scheduling and planning, trip and activity actions. Consequently, the Person entity defines a *highly structured class*. This leads to design an object of type Person as a composition of a set of external objects such as Trip, Activity, Activity Location, Activity Plan and Activity Scheduling.

These objects should be designed in a way that makes them able to respond seamlessly to a variety of spatio-temporal queries concerning their actions. Effectively, this constraint means that each significant object should *remember* its complete history by storing, retrieving and managing its own memory of events. For example, the object Person should be able to reveal its behavior by retrieving the trips it made, the activities it performed, the activity locations it visited, the activity scheduling it decided, and the planning it organized.

Moreover, objects should record active actions (performed by the object on other objects), and passive actions (performed upon the object by other objects) to be able to trace back the events they participate in. Because the application time is organized in ascendant order from past to future through present, the designed objects should *embed* three instances of each of its constituent objects: the previous instance (dealing with past time), the current instance (dealing with present time), and the next instance

(dealing with future time). Since actions have an initiator, a start time, an end time, a duration and a location, such a design enables the space-time dimension to be explicit and *orthogonal* to each of the definition of the concerned objects.

Given that each object *encapsulates* its own history, spatio-temporal queries are, henceforward, submitted to single objects. Data collection from dispersed tables is replaced by a dynamic navigation through single object historical events. Thus, for the Person object, it means a depiction of displacements and activities during the transit day cycle, on the road network and in activity places.

To design the data model, we used object-oriented design guidelines defined in Rumbaugh et al. (1991), Blaha and Premerlani (1998), Booch (1999) and Booch et al. (1999). These guidelines are incorporated in the Unified Modeling Language, UML (Boggs and Boggs 1999) that is widely used by the industry as the object-oriented formalism standard. The complete system objects diagram is displayed in Figure 1 as drawn by Microsoft Visio 2000<sup>TM</sup> UML stencil.

Person object is defined as a compound object containing Trip object and Activity object (aggregation concept). The Trip object is associated with the Purpose object and with the Mode object. Thus, the Trip object can be instantiated by a mono- or multi-modal and/or a mono or multi-purpose trip. Each object hides its implementation details from other objects, and information exchange is made through message sending and receiving (object interfacing and encapsulation). For example,

the Person object (client) sends the `Get_Person_Time_Ordered_Activity_Collection()` as a message to the Activity object (server) asking for an activity list. The way the Activity object computes the list is hidden to the Person object. Figure 2 shows a sample of message exchanges between objects.

For implementation, Smallworld GIS 3.1<sup>TM</sup> was used as a host development shell. It has a strong version based database management system, the hybrid language programming Magik (object-oriented/procedural) is versatile, and the class library is extensible. Another important feature is the integrated Case Tool which helps to design and implement database schema, to verify its coherence, and to store its different versions.

The available sample data sets are drawn from three sources. The first is the Québec region Origin-Destination (O-D) survey conducted in 1991 by the STCUQ (Quebec Urban Community Transit Authority). It is composed of more than 110,000 trips records stored in a dbase file format. The second source is the activity places located using Statistics Canada's Postal Code Conversion Files (PCCF). The third source is the Québec region non-planar streets network (Thériault *et al.* 1998). The sample spatial data sets are in ESRI shape file format<sup>TM</sup>.

The spatial sample data sets were imported into Smallworld by using the Feature Manipulation Engine (FME<sup>TM</sup> for Smallworld) conversion utility program. The O-D sample data set was imported using coded Magik procedures. As a first milestone of



the project, we developed a proof-of-concept prototype that is able to: (1) map the system objects diagram into a physical database system populated by sample data sets, and (2) navigate the database and query the implemented objects. The next section describes a query session using the prototype.

The developed database prototype reproduces the complexity of the conceptual data model articulated around the individual behavior. As illustrated by Figure 3, the hierarchical structure of the data model is replicated from the household level to the activity places level. In the following, explicative comments show the way the prototype is behaving as expected.

The Household editor (1) shows an instance of the Household object. This instance has four members (persons). When clicked, the button located after the “Household Members” will display the household members list in the Person browser (2). When clicked, the first row of this browser will display an instance of the Person object in the Person editor (3).

The *time ordered collection* of the trips made by the person is displayed in the Trip browser (4) when the button located after the “Time Ordered Trips Collection” field in the Person editor (3) is clicked. The Trip Start Time column values are sorted by time in an ascending order.

The *time ordered collection* of the activities performed by the person is displayed in the Activity list browser (5) when the button located after the “Time Ordered Activities Collection” field in the Person editor is clicked.

The Trip editor (6) shows an instance of the Trip object when its corresponding row in the Trip browser (4) is clicked. The button located after the field “Trip Related Activity” of the Trip editor offers access to the activity performed *after* the currently loaded trip (7).

The Activity editor (7) shows an instance of the Activity object when its corresponding row in the Activity browser (5) is clicked. The button located after the “Activity Related Trip” field offers access to the trip made by the person *before* the currently loaded activity.

Taken together the Trip and Activity browsers (4 and 5) show a unified view of the time sequence of trips made and activities performed by a person. Both of them converge into the Activity editor (7). This editor offers access to the Activity Place object where the activity was performed. If clicked, the button located after the “Activity Place Location” field brings the Activity Place editor (8). This editor offers access to the spatial object representing the Activity Place on the GIS application main window (9) where the road network is shown as line segments and the activity places are shown as triangular dots. Therefore, a specific person space-time path starting with a trip and ending with an activity is traced back and easily followed.

## Discussion

The proof-of-concept prototype that was developed leads to interesting observations. The first refers to the possibility of conducting a smooth transition from an OO conceptual data model to a physical data model by using exclusively the OOP. In our case, we mapped our model as it is into Smallworld GIS. The original survey sample data sets served as a pool from which we picked up fields to build model object attributes and records to create instances of these objects. This approach is more authentic in terms of OOP modeling than the one used in Makin et al. (1996) where the relational approach was called in to rescue model attribute data.

The second observation is the ability of the OOP to capture the semantics of a complex domain such as the ABTB. The ABTB domain considers individual as the most important actor in the event time sequences of trips and activities. This fact is denoted in our model by the axial position occupied by the object Person. Other objects such as Trips, Activities or Activity Places participate in the making of the central object aggregated identity. Meanwhile, these objects are not defined only by their supporting role. They have their own proper identities, which can be an aggregation or a generalization of other objects.

This complex object-identity definition approach is enforced by allowing the objects the capacity to manage their own memory of events. Objects are enabled to perform

housekeeping tasks such as storing, modifying and retrieving events in which they participate actively or passively. This strict encapsulation of “real live duties” into object definition ensures a sharp and rich semantic rendering. Even if most of the essential entities (real life entities such person, household, activity, trip etc...), and constructed entities such as complex associations, activity scheduling and planning which populate the ABTB universe of discourse are covered and represented, the data model does not pretend to be ontologically exhaustive. However, this is not a major issue because it lays on OOP. This representation approach is flexible enough to integrate newly discovered entities. The model can therefore seamlessly enhance its richness.

In terms of extension, our model lays the foundation to augment the object capabilities, particularly for the object Person. Actually, this object is a “dumb” one whose spatial behavior is controlled by the finite sequences of trips it already made. If imparted with a plan scheduling decision rules base (as in knowledge databases), it can build “intelligently” its own space-time path. This innovation would produce a “space-time intelligent agent” that is suited to travel behavior simulation.

With the developed prototype, we obtain objects able to answer spatio-temporal queries about themselves and about associated objects. This ability simplifies query management in comparison to the relational approach that is greatly dependent on joining fragmented and normalized tables to gather data sets. As a proof, the

prototype can retrieve objects and display their attributes and components as they are conceptually defined in Figure 1.

However, the major deficiency of the prototype is that it has no means to explicitly exhibit the object's histories, e.g. objects space-time paths. For instance, the object Person is not able to expose its embedded event time sequences and transition. This points to the static nature of a prototype developed into a GIS shell devoid of temporal reasoning. Consequently, the functions of the actual prototype should be enhanced in order to meet the project specifications. This constitutes the next phase of this research. First, we will transform the static prototype into a dynamic one by developing a temporal query extension as a counterpart to the GIS shell spatial query engine. This extension will enable the prototype to become a factory of spatio-temporal data sets providing data infrastructure for micro-simulation models. Second, we will develop an interface that transforms the spatio-temporal data sets into a graphical depiction of space-time paths and locations on a map. In this way, the space-time path will be revealed and would be able to be visually investigated.

## **Conclusions**

In this paper, we characterized the urban transportation system (UTS) as a complex system, and discussed its data representation issues from the object-oriented modeling paradigm. We presented the data model we have designed. This model intensively uses the encapsulation concept, which allowed us to conceive of independent objects endowed with space-time semantics and a rich set of services.

The proof-of-concept prototype demonstrates that each object has the needed foundation to act as a stand-alone spatio-temporal server and to provide answers to queries related to its domain. In the case of object representing individuals, this foundation can be enhanced to transform it from a “dumb” agent to an “intelligent” one.

Even if the prototype reproduces the semantic richness of the ABTB application domain, it is still a static GIS database devoid of temporal reasoning capabilities. Actually, the user needs some mental effort to interpret the space dynamics embedded into the database. We need a temporal GIS to animate maps for furthering exploration, discovery and process understanding. Basically, this ability is wrapped around a query engine that sustains seamless spatio-temporal queries and a set of graphical symbols representing static and dynamic visual variables.

The challenge is to transform the actual database from its static behaviour schema into a temporal schema needed to generate dynamic maps. The next stage of our project will be the design and development of an easy-to-use interface that permits the dynamic cartography of individuals and group movements on an urban streets network. We intend to achieve this goal by: (1) adding temporal query capabilities to the Smallworld GIS spatial query engine, and (2) developing a tool to graphically transform spatio-temporal query result sets into space-time paths and locations. The interface is intended to be useful for urban transportation decision makers and

researchers. The long-term purpose is to simulate travel behaviour, explore travel data analytically, and predict new urban trends.

## **Acknowledgments**

This research is funded by the Canadian Natural Sciences and Engineering Research Council (NSERC), and the Canadian Network of Centers of Excellence in Geomatics (GEOIDE). OD survey data were provided by the Transportation Society of the Urban Community of Quebec City and the Ministry of Transportation of Quebec.



## References

- Abraham T and Roddick J F 1999 Survey of spatio-temporal databases. *Geoinformatica* 3: 61-99
- Aerts D, Apostel L, De Moor B, Hellemans S, Maex E, Van Belle H, and Van Der Veken J 1994 *World view: From fragmentation to integration*. Brussels, VUB Press
- Al-Taha K, Snodgrass R T, and Soo M D 1993 The Tempis project, bibliography on spatiotemporal databases. University of Arizona, Department of Computer Science Tempis Technical Report No 44
- Ashby W R 1957 *An introduction to cybernetics*. London, Chapman and Hall
- Bédard Y 1999 Principles of spatial databases analysis and design. In Longley P A, Goodchild M F, Maguire D J and Rhind D W (eds) *Geographical Information Systems*. New York, John Wileys and Sons: 413-424
- Blaha M and Premerlani W 1998 *Object-oriented modeling and design for database applications*. New Jersey, Benjamin/Cummings
- Boggs W and Boggs M 1999 *Mastering UML with Rational Rose*. San Francisco, Sybex
- Booch G 1999 *Object-oriented analysis and design with applications* (Second Edition). Reading, MA, Addison-Wesley
- Booch G, Rumbaugh J, and Jacobson I 1999 *The Unified Modeling Language User Guide*. Reading, MA, Addison-Wesley

- Chen J and Jiang J 2000 An Event-based Approach to Spatio-Temporal Data Modeling in Land Subdivision Systems. *Geoinformatica*, 4:387-402
- Chen P P 1976 The entity relationship model: towards a unified view of data. *ACM TODS* 1: 9-36
- Cheng T S and Gadia S K 1992 A seamless object-oriented model for spatio-temporal databases. Iowa State University, Computer Science Department, Technical Report Tr-92-41
- Claramunt C and Jiang B 2000 Hierarchical Reasoning in Time and Space. In Forer P, Yeh A and He J (eds.) *Spatial Data Handling 2000*, Beijing, China.
- Claramunt C, Parent C, and Thériault M 1997 Design patterns for spatio-temporal processes. In Spaccapietra S and Maryansky F (eds) *Data mining and reverse engineering*. London, Chapman & Hall: 455-475
- Claramunt C, Thériault M, and Parent C 1998 A qualitative representation of evolving spatial entities in two-dimensional topological space. In Carver S (editor) *Innovations in GIS*. London, Taylor & Francis:128-139
- Claramunt C and Thériault M 1996 Toward semantics for modeling spatio-temporal processes within GIS. In Kraak M J and Molenaar M(eds) *Proceedings of the 7th International symposium on Spatial Data Handling*. Thijsseweg, Delft University of Technology, Faculty of Geodetic Engineering:2.27-2.43
- Coad P and Yourdon E 1990 *Object oriented analysis*. New Jersey, Yourdon Press
- Courtois P J 1985 On time and space decomposition of complex structures. *Communications of the ACM* 28:590-604

- De Rosnay J 1979 *The macroscope, a new world scientific system*. New York, Harper and Row
- Dial R B 1976 Urban transportation planning system: philosophy and function. *Transportation Research Record* **599**:60-64
- Dickey J W 1983 *Metropolitan transportation planning*. New York, Hemisphere Publishing Company
- Egenhofer M J and Frank A U 1992 Object-oriented modeling for GIS. *Urban and Regional Information Systems Association Journal* **4**:3-19
- Ettema D and Timmermans H 1999 *Theories and models of activity patterns*. In Ettema D and Timmermans H (eds) *Activity based approaches to travel analysis*. UK, Elsevier Science ltd: 1-35
- Golledge R G 1998 The relationship between geographical information systems and disaggregate behavioral travel modeling. *Geographical Systems* **5**: 9-17
- Golledge R G, Kwan M P, and Garling T 1994 Computational process modeling of household travel decisions using a geographical information system. *Papers in regional science* **73**:99-117
- Golob J M and Golob T F 1982 Classification of approaches to travel-behavior analysis. *Transportation Research Board, Special Report* **201**: 83-127
- Greaves S and Stopher P 1998 A synthesis of gis and activity-based travel forecasting. *Geographical Systems* **5**:59-89
- Hägerstrand T 1970 What about people in regional science?. *Papers of the Regional Science Association* **4**:7-21

- Honsby K, Egenhofer M J, and Hayes P 1999 Modeling Cyclic Change. In Chen P, Embly D, Koulondjan J, Liddle S and Reddinck J (eds) *Advances in Conceptual Modelling*. Edinburgh, Springer-Verlag, Lecture Notes in Computer Sciences **1227**:98-109
- Hornsby K and Egenhofer M J 2000 Identity-based Change: A Foundation for Spatio-temporal Knowledge representation. *International Journal of Geographical Information Science* **14**:207-224
- Hunter G J and Williamson I P 1990 The development of a historical digital cadastral database. *International Journal of Geographical Information Science* **4**:169-179
- Jomier G, Peerbocus M A, and Huntzinger J B 2000 Visualizing the Evolution of Spatiotemporal Objects. In Forer P, Yeh A and He J (eds.) *Spatial Data Handling 2000*, Beijing, China, 7a: 13-25
- Joseph V J, Thatte S M, Thompson C W, and Wells D L 1991 Object-oriented databases : Design and implementation. In *Proceedings of the IEEE 1991*. Los Alamitos, IEEE Computer Society Press: 42-64
- Karimi H A and Lee Y C 1995 Semantic data models in GISs and object orientation. In *The Ninth annual symposium on geographic information systems*. Fort Collins, GIS World Inc.:407-412
- Kemp Z and Kowalczyk A 1994 Incorporating the temporal dimension in a GIS. In Worboys, M. F. (editor) *Innovations in GIS*. London, Taylor & Francis:89-103

- Kline N 1993 An update of the temporal database bibliography. *Association for Computing Machinery SIGMOD Record* **22**:66-80
- Kwan M 1998 Space-time and integral measures of individual accessibility: A comparative analysis using a point-based framework. *Geographical Analysis* **30**:191-216
- Kwan M 1999 Gisicas: An activity-based travel decision support system using a GIS interfaced computational-process model. In Ettema D and Timmermans H (eds) *Activity based approaches to travel analysis*. UK, Elsevier Science Ltd: 263-282
- Kwan M and Hong X 1998 Network based constraints oriented choice set formation using gis. *Geographical Systems* **5**:139-162
- Langran G and Chrisman R 1988 A framework for temporal geographic information. *Cartographica* **25**:1-14
- Lee H and Kemp Z 1998 Supporting complex spatiotemporal analysis in GIS. In Carver S (editor) *Innovations in GIS*. London, Taylor & Francis:151-161
- Lenntorp B 1978 A time-geographical simulation of activity programs. In Carlstein T, Parkes D and Thrift N (eds) *Timing Space and Spacing Time, Volume 2: Human Activity and Time Geography*. London, Edward Arnold Ltd:162-180
- Makin J, Healey R G, and Dowers S 1996 Simulation modelling with object-oriented GIS: a prototype application to time geography of shopping behavior. *Geographical Systems* **4**:397-429

- Mattos N M, Meyer-Wegener K, and Mitschang B 1993 Grand tour of concepts of object-orientation from a database point of view. *Data & Knowledge Engineering* **9**:321-352
- McNally M G 1998 Activity based forecasting models integrating gis. *Geographical Systems* **5**:163-187
- Meyer M D 1984 *Urban transportation planning: a decision oriented approach*. New York, McGraw-Hill
- Miller H J 1991 Modelling accessibility using space-time prism concepts within geographical information systems. *International Journal of Geographical Information Science* **5**:287-301
- Miller H J 1998 Emerging themes and research frontiers in gis and activity-based travel behavior forecasting. *Geographical Systems* **5**:189-198
- Miller H J 1999a Measuring space-time accessibility benefits within transportation networks: Basic theory and computational procedures. *Geographical Analysis* **31**:187-212
- Miller H J 1999b Potential contribution of spatial analysis to geographic information systems for transportation (GIS-T). *Geographical Analysis* **31**:373-409
- Milne P, Milton S, and Smith J L 1993 Geographical object-oriented databases: a case study. *International Journal of Geographical Information Science* **7**:39-55
- Newell R G 1992 Practical experiences of using object-orientation to implement a GIS. In *Proceedings of the GIS/LIS*. Bethesda, American Society for Photogrammetry and Remote Sensing:624-629

- O'Sullivan D, Morrison A, and Shearer J 2000 Using desktop GIS for the investigation of accessibility by public transport: an isochrone approach. *International Journal of Geographical Information Science* **14**:85-104
- Panopoulos G and Kavouras M 2000 Spatio-temporal Modelling: incorporating the Concept of Change in Socio-Economical Applications. In *Proceedings of the Third Agile Conference of Geographic Information Science*, Helsinki, Finland:205-208
- Parent C, Spaccapietra S, Zimanyi E, Donini P, Plazanet C, Vangenot C, Rognon N, and Crausaz P A 1997 MADS, modèle conceptuel spatio-temporel. *Revue Internationale de Géomatique* **7**:317-352
- Parsay K, Chignell M, Khoshafian S, and Wong H 1989 *Intelligent databases*. New York, John Wileys and Sons
- Peuquet D 1994 It about time: A conceptual framework for the representation of temporal dynamics in geographic information systems. *Annals of the Association of American Geographers* **84**:441-461
- Peuquet D and Duan N 1995 An event-based spatio-temporal data model (ESTDM) for temporal analysis of geographic data. *International Journal of Geographical Information Science* **9**:7-24
- Raper J and Livingstone D 1995 Development of geomorphological spatial model using object-oriented analysis. *International Journal of Geographical Information Science* **9**:359-383
- Renolen A 2000 Modelling the real world: Conceptual modelling in spatiotemporal information system design. *Transactions in GIS* **4**:23-42

- Rojas-Vegas E and Kemp Z 1995 An object-oriented data model for spatio-temporal data. In *The Ninth annual symposium on geographic information systems*. Fort Collins, Gis World Inc.:399-406
- Rumbaugh J, Blaha M, Permerlani W, Eddy F, and Lorenson W 1991 *Object-oriented modeling and design*. New Jersey, Prentice Hall
- Scarponcini P, 1995 Object-oriented vs. relational database management systems for GIS. In *Proceedings of Urban and Regional Information Systems Association 1995*: 445-461
- Sinton D F 1978 The Inherent Structure of Information as a Constraint to Analysis: Mapped Thematic Data as a Case Study. In G.H. Dutton (Ed.), *Harvard Papers on Geographic Information Systems*, Vol. 7, Reading, Massachusetts: Addison-Wesley.
- Spear B D and Lakshmanan T R 1998 The role of GIS in transportation planning and analysis. *Geographical Systems* 5:45-58
- Stopher P R and Lisco T E 1970 Modelling travel demand: Disaggregate behavioral approach, issues and applications. *Transportation Research Forum* :195-214
- Summers M and Southworth F 1998 Design of a testbed to assess alternative traveler behavior models within an intelligent transportation system architecture. *Geographical Systems* 5:91-115
- Thériault M and Claramunt C 1999 La représentation du temps et des processus dans les SIG: Une nécessité pour la recherche interdisciplinaire. *Revue Internationale de Géomatique* 9:67-99



- Thériault M, Claramunt C, and Villeneuve P Y 1999 Spatio-temporal taxonomy for the representation of spatial set behaviour. In Böhlen M, Jensen C, and Scholl M (eds) *Spatio-Temporal Database Management*. Edinburgh, Springer-Verlag, Lecture Notes in Computer Sciences **1678**:1-19
- Thériault M, Leroux D, and Vandersmissen M H 1998 Modelling travel route and time withing gis: its use form planning. In Bergelia A., Kerckhoffs E. (ed.) *The 10th European Simulation Symposium (October 26-28, 1998)*. Delft, Society for Computer Simulation International: 402-407
- Tsotras V J and Kumar A 1996 *Temporal database bibliography update*, 1996. New York, Polytechnic University, Department of Electrical Engineering and Computer Science
- Turchin V F 1977 *The phenomenon of science*. York, Culumbia University Press
- Vandersmissen M H, Villeneuve P and Thériault M 2001 La mobilité des femmes dans la région de Québec : quels changements depuis les années 1970. *Cahiers de géographie du Québec*, **45**(125) :211-243
- Van der Knaap W G M 1999 Analysis of time-space activity patterns in tourist recreation complexes, a gis oriented methodology. In Ettema D, Timmermans H (eds) *Activity based approaches to travel analysis*. UK, Elsevier Science ltd: 283-311
- Wachowicz M 1999 *Object-oriented design for temporal databases*. London, Taylor and Francis
- Wachowicz M and Healey R G 1994 Towards temporality in GIS. In Worboys, M. F. (editor) *Innovations in GIS*. London, Taylor & Francis:105-115

- Wang D and Cheng T 2001 A spatio-temporal data model for activity-based transport modeling. *International Journal of Geographical Information Science* **15**:561-585
- Wiegand N and Adams T M 1994 Using object-oriented database management for feature-based GIS. *Urban and Regional Information Systems Association Journal* **6**:21-36
- Worboys M F 1994 Object-oriented approaches to geo-referenced information. *International Journal of Geographical Information Science* **8**:385-399
- Worboys M F, Hearnshaw H M, and Maguire D J 1990 Object-oriented data modeling for spatial databases. *International Journal of Geographical Information Science* **4**:369-383
- Worboys M F 1999 *Relational databases and beyond*. In Longley P A, Goodchild M F, Maguire D J, Rhind D W, (eds) *Geographical Information Systems*. New York, John Wileys and Sons:373-384
- Yuan M 1994 Wildfire conceptual modeling for building GIS space-time models. In *Proceedings of GIS/LIS 1994*. Bethesda, American Society for Photogrammetry and Remote Sensing:860-869

Le premier chapitre décrivait le cadre théorique et la méthodologie utilisés pour la modélisation du domaine du comportement de transport basé sur l'activité ainsi que de l'implantation d'une base de données dans un prototype hébergé par une coquille SIG statique. Le second chapitre expose l'approche adoptée afin de modéliser et d'implanter les requêteurs temporels et positionnels.

## **Chapitre II- Querying Travel Behavior Time Paths: Bringing Life into a Static GIS**

Ali Frihida\*



Danielle J. Marceau\*



Marius Thériault\*\*



\*Geo-Computing Laboratory, Département de Géographie, Université de Montréal

\*\*Centre de Recherche en Aménagement et Développement, Université Laval

Cet article papier a été soumis pour publication à la revue *Geoinformatica*.

## Abstract

There is a relative consensus in the database community about the essential protocols needed to implement temporality into geographical information systems. We used these protocols to transform a static object-oriented travel behavior database prototype into a temporal one and to build a set of methods that implements temporal predicates as an interface to temporally query the database. We noted that these protocols are unable, at the design level and at the query level, to deal with the activity-based travel behavior (ABTB) main unit of analysis, namely the space-time path. In this paper, we propose a design approach oriented to the modeling of the time path and the retrieval of its event chaining. In this approach, time path is formulated as a totally time ordered set composed by activity events and trip events, themselves organized into time ordered sets. As sets, the time path and its components can be searched using their respective indexes. We designed a set of positional operator methods that transform temporal topological queries into retrieval functions based on set ordering indices. Taken together, the temporal predicates and the positional operator methods define a temporal query extension that meets the retrieval needs of an ABTB database.

**Keywords:** Temporal GIS, disaggregate travel behaviour, space-time path, time topology, temporal query, object-oriented paradigm

## Introduction

To analyze travel behavior at the disaggregate level, researchers need to feed their micro-simulation and forecasting models with spatio-temporal information drawn from Origin-Destination (O-D) surveys. To provide this data infrastructure, we designed a data model [7] that considers the disaggregate travel behavior under the time geography framework [10]. This framework opened new horizons in the modeling of the activity-based behavior by anchoring it to a spatio-temporal container acting as a scene, a resource pool and a constraint generator. The potential of using this framework in modeling activity-based travel behavior was revealed by Lenntorp [17]. He employed the framework to simulate mobility in the urban area. He used the space-time prism concept to refer to the areal extension that can be accessible to a specific time budget in respect to some physical and environmental constraints. To convey to the events completed by an individual, the space-time path concept is employed to trace back the individual event-chaining log. The trip-activity chaining as a main analysis unit in the activity-based travel behavior (ABTB) domain can be seen as a specific case of the space-time path.

In a pioneer work, Miller [20] demonstrated the great potential of coupling ABTB modeling with geographic information system (GIS) technology to operationalize the time geography concepts. The ARC/INFO™ based application he developed left no doubts about the seriousness of his claims even if he used experimental data sets. Since, the GIS-ABTB coupling became a promising research field. Examples of GIS-

ABTB applications include the implementation of activity-based forecasting models [19], simulation of shopping behavior [18] as well as modeling facility accessibility ([21],[23]), modeling activity-scheduling ([8],[15]), travel decision-making ([14],[16],[15]), and activity patterns ([29]).

In these applications, the temporal dimension of the ABTB is always recognized (explicitly or implicitly) as a main property of the domain. But this concern is not supported by a sustainable endeavour to model temporality and to make it available for query and retrieval operations. More recently, Wang and Cheng [31] presented an activity-based data model built using the extended entity-relationship methodology (EER). Once mapped into a Microsoft Access™ DBMS (provided with a reduced SQL capabilities) coupled with ESRI Arcview™, the model implemented temporality by two ways:

- (1) A couple of temporal attributes referring to the start time and the end time of an event in the *Travel\_Between* table and the *Stay\_At* table. This approach is proposed in Snodgrass [25].
- (2) A *before* and *after* relationship that permits to navigate through the topology of trips (*Travel\_Between*) and activities (*Stay\_At*). Thus, the immediately after and immediately before events relative to a given event can be retrieved. This implementation offers a basic set of topological navigation means.

Although the application renders most of the semantics of the domain at the conceptual level, it proposes only a basic temporal query interface. This fact contrasts

with the authors' legitimate stress on the importance of the activity-based pattern analysis as a rich track to understand disaggregate travel behavior [31]. The ABTB database needs more than a reduced SQL based interface and a simple before-after navigation tool. Such a database must provide a temporal handle over the activity-based events (activities performed and trips made) and the space-time path permitting their query, retrieval and analysis. The handle should be tailored to the very nature of the activity, the trip as an atomic temporal entity and the space-time path as an aggregate temporal entity that embeds the temporal topological order of individual activity-based events.

The aim of this study is to propose a solution that surmounts the previously noticed temporal shortcomings. In the following, we present the ABTB data model we developed and implemented into a database prototype hosted by a GIS shell. In addition, we discuss the limitations of the actual database prototype to emphasize the need for a temporal query interface that permits the query and the retrieval of the ABTB events on the basis of their temporal properties and order.

The analysis of the ABTB domain assigns to the Person entity the principal role [7]. It is composed of cognitive tasks such as trip decision-making, activity planning and scheduling, and spatio-temporal involvement by traveling to activity places and by performing activities. Consequently, the Person entity defines a highly structured class profile. The data model renders this complexity by designing an entity of type Person that is an aggregation of sets of external entities such as Trip, Activity,



Activity Plan and Activity Scheduling. Moreover, each significant entity is designed to be “aware” of its own memory of events. By this way, the data model entities are viewed as standalone data servers able to respond to a variety of spatio-temporal queries concerning their historical states.

To represent the semantic complexity of the application domain, we used the object-oriented paradigm formalism. The sample data sets are drawn from an O-D survey and two geobases. The O-D survey was conducted by the STCUQ (Quebec Urban Community Transit Authority) and the MTQ (Ministry of Transportation of Quebec) in the Québec region in 1991. It records more than 110,000 trip cases and it is located using two GIS databases. The first geobase locates activity places spatially referenced using Statistics Canada’s Postal Code Conversion Files (PCCF). The second geobase is the Québec region non-planar street network [26].

Using these data sets, we generated a set of objects matching those identified by the data model and we smoothly mapped them into a prototype database schema hosted by Smallworld GIS 3.1<sup>TM</sup>. The prototype permits to retrieve the trip and activity components for each person object. In addition, the trip object points out to its purpose (activity object) and to its initiator (person object). The activity object displays the trip object ending at its location and the person object that performed the activity. These semantic associations between objects are achieved through a set of messages that fire methods interfacing between objects. As depicted in the collaboration diagram of the prototype (Figure 1), trips made by a person can be

retrieved by sending a message to the trip object, which is acting as a server. The trip object activates an internal method used to collect the specific trip objects, which are related to the person, and returns a result set named `Person_Time_Ordered_Trip_Collection`. The returned result set is, in fact, the trip instances of the aggregated person object. A similar approach combining message and result set implements the activity instances as a component of the person object.

Despite this achievement, the prototype is far from meeting the project specification concerning the ability to trace back the ABTB event chaining and providing comprehensive space-time data sets which represent the chaining of activities and trips performed by an individual. At this stage, this task is left to the user who needs a challenging mental effort to reconstruct a person space-time path by merging and sorting activity and trip information chunks. In fact, the user has no tools that permits to time-select specific objects or to get a handle on a specific space-time path and navigate its edges and vertices using queries.

Such limitations are partly due to the way O-D surveys are conducted. The survey protocols record only the time instants when the trips occurred. When we fragmented the original data matrix into objects, this temporal attribute was inherited by the trip object. The trip object time stamp was used to organize a sort order of the trip component. Even if it is a temporal object, the activity object has no temporal attributes embedded in it. The activity component order of the person object is deduced from the sequence of the trips (activities are intercalated between trips).

Besides this “semantically deduced” temporality, the prototype has no means to check the validity of the temporal order of events and furthermore to submit temporal queries that can trace back sequences of events.

Therefore, we need to transform this temporally “basic” database schema into a fully temporal one. Transforming a non-temporal database into a temporal database is an active research field ([13],[12],[25]; for bibliography see [2],[4],[28]). Temporal database design and implementation protocols can be summarized into three steps: 1) identification and modeling of the time concepts relevant to the application domain, 2) incorporation of these concepts into the application data model, and 3) development of a temporal querying engine that implements Allen’s temporal predicates [1] to manipulate the newly added time structures.

Even if those protocols are mandatory and can transform a complex domain schema such as the ABTB database into a standard temporal one, the resulting database shortly fails to address and manage a fundamental property of the ABTB: its analysis unit, namely the *space-time path* as a continuous activity and trip chain [9]. The space-time path can be compared to a graph of time bound connections and states. Its (re)-construction should permit to perform scientific tasks such as: *prediction* of future states, *explanation* of past states, *learning new rules* from recurrent facts, and *planning* for still-to-come outcomes ([24],[30],[27]) through hypothesis formulation, simulation, forecasting and induction.

The spatial part of the space-time path can be easily rebuilt and manipulated by calling the network analysis utility of the host GIS shell. However, there is no such utility to manage the temporal aspect. To provide a tool that permits the time path manipulation, we need to design and implement a navigation and query tool. Thus, the objective of this second phase of the study is to transform the actual temporally basic database schema into a fully temporal one. In addition, we entail to develop a temporal query extension. This query extension should be able to handle two kinds of queries: 1) the standard selection query based on temporal predicates, and 2) the event chain query oriented to the retrieval of specific event on the basis of its position in the chain order of a component (trip and activity) or in a time path.

This paper is organized into three sections. The first section covers the methodology we used to transform our actual database schema into a temporal one including the query extension we implemented. The second section provides examples of temporal queries addressed to the database through the temporal query extension. The third section is devoted to the illustration of the achieved results.

## **Methodology**

The O-D survey data stores a large variety of individual travel behavior cases. For the sake of our modeling, we regarded as degenerated the following cases: 1) individuals who have no trip and no activity outside of their home in their diary scheduling, 2) individuals who made two or more successive similar events (a trip followed by a trip

or an activity followed by an other activity at the same location), and 3) individuals who are road workers such as cab and bus drivers. These cases are excluded and we limited our modeling to their complementary set.

The modeling goal is the uncovering of the rules that should govern the internal ordering of the temporal objects as packaged into the highly structured objects. This ordering is justified by the mandatory respect to the semantics of these objects where the time is orthogonal to their identity. In addition, the ordering establishes the temporal semantic integrity rules that should be applied against the database content to bear out its temporal coherence.

In a first step, we consider a trip or an activity event as the atomic element of the time path and we defined its semantic and syntax using the set theory. In a second step, we characterize the first level of the event aggregation in the form of the activity chaining and the trip chaining. In a third step, we characterize the upper level of the event aggregation, which makes the time path. These characterizations are at the basis of the design and the implementation of a set of methods that will constitute a temporal query extension to the actual prototype.

In the following sections, we model events in the context of the ABTB domain. Afterwards, we model activity events and trip events. Finally, we model the time path.

## Identification and modeling of events, activity events and trip events

For our application, we identified a structural time concept anchored to the application time line: the valid time. The valid time is associated with an event (a trip or an activity) that happened in reality. The couple of a start time stamp and an end time stamp delimits the time span boundaries (interval) of an event and defines it as a period. In the following, we model the event entity and use the resulting model as a building block for more advanced characterizations.

We assume that  $T$  is the set of the ABTB domain time instants.

$T * T = T^2$  as the Cartesian product of  $T$ . (1)

An event (a period) is a temporal object (activity or trip) delimited by a starting time instant ( $t_s$ ) and an ending time instant ( $t_e$ ) where  $t_s$  and  $t_e$  are isomorphic to positive real numbers ( $t_s > 0$  and  $t_e > 0$ ). While omitting the event identity parameter, an event  $E$  is composed of the couple  $(t_s, t_e)$ . Consequently, we define an event as the following:

$$E = \{ t_s, t_e \in T^2 \mid t_s < t_e \}. \quad (2)$$

This stands for the extreme limits of each event and the constraint implying the positive difference between the event starting time and the event ending time.



$\bigcup_{i=1}^n Ei \subseteq T^2$ . This stands for the closure of all the ABTB survey events. (3)

A is the set of activity events;  $A \subset \bigcup_{i=1}^n Ei \subseteq T^2$ . (4)

M is the set of trip events;  $M \subset \bigcup_{i=1}^n Ei \subseteq T^2$ . (5)

$A \cup M = \bigcup_{i=1}^n Ei$ . (6)

$A_i$  is the set of activity events performed by an individual  $i$  and  $M_i$  is the set of trip events made by an individual  $i$ .

$A_i$  is a totally ordered set =  $E_n \in A_i \mid t_e \in E_n < t_s \in E_{n+1} \cap t_s \in E_n < t_s \in E_{n+1}$ .  $A_i$  is non-reflexive, non-symmetric and transitive (7).

Thus,  $A_i$  denotes a chain of activity events as in Figure 2.

$M_i$  is a totally ordered set =  $E_n \in M_i \mid t_e \in E_n < t_s \in E_{n+1} \cap t_s \in E_n < t_s \in E_{n+1}$ .  $M_i$  is non-reflexive, non-symmetric and transitive (8).

Thus,  $M_i$  denotes a chain of trip events as in Figure 3.

(7) and (8) are in fact ascending order sorted sets in respect to the forward direction of O-D survey time. To insure that the same individual can not be involved in an



activity event and a trip event in the same time interval, we added the following constraint:

$A_i \cap M_i = \emptyset$  which stands for the absence of two events having the same starting and ending times. (9)

### Modeling the time path chains

From (6), (7), (8) and (9), we draw  $A_i \cup M_i = P_i \subset \bigcup_{i=1}^n Ei$  where P is the time path for an individual i. (10)

The time path is the sequence of activity events and trip events made by an individual during the ABTB survey starting and ending times.  $P_i$  denotes a chaining where activities and trips are timely intercalated as in Figure 4.

$P_i$  is a totally ordered set =  $\forall E_n \in P_i \mid t_e \in E_n < t_s \in E_{n+1} \cap t_s \in E_n < t_s \in E_{n+1}$ .  $P_i$  is non-reflexive, non-symmetric and transitive (11).

$\bigcup_{i=1}^n P_i = \bigcup_{i=1}^n Ei \subseteq T^2$ . This stands for the closure of the time paths covered by the set of

the individuals targeted by the disaggregate travel behavior survey.

As for the activity event and the trip event, the time path event can be the target of either temporal selection query or positional query. In the following, we present the way we used to implement the foregoing linear time sets into the database prototype.

### Implementing time data structures

At the data model conceptual level, we embedded time orthogonally into each temporal objects. To realize this embedding, we need to map the preceding event temporal definition into these objects as a couple of time instant attributes referring to the start time and the end time.

The Québec région Origin-Destination (O-D) survey conducted in 1991 recorded only the starting time of the trip event. It is represented by a time point (instant). This time point can be used to derive event end time and event period at *run time* either for trips or for activities. During the prototype implementation process, the survey data table was fragmented to derive objects such as person, trip and activity. The trip object kept the starting time attribute but the activity object was devoid of temporal attributes. We modified the data model by adding new attributes to the trip and the activity objects as a way to physically represent the new temporal construct.

Thus, for the trip object, we added a trip end time instant attribute in order to delimit the end of the trip event. Its value is dependent on the trip starting time added to the time used to travel from an origin location to a destination location. Therefore, the trip valid time is represented by an interval delimited by the trip starting time and the trip ending time.

In the activity object, we incorporated a start time attribute and an end time attribute. The start time attribute value is defined by the end time of the previous trip in the event sequence related to a person. The activity end time value is the start time of the next trip in the event sequence related to a person. Therefore, the activity valid time is represented by an interval delimited by the activity starting time and the activity ending time.

Also, we added duration as an extra temporal attribute to the trip object and to the activity object. Its value is defined by the end time attribute value minus the start time attribute value.

The data model modifications are done in respect with the ability of the host DBMS to manage time data types. Smallworld GIS implements some of the Structured Query Language 1992 (SQL92) specifications on date and time [25]. It has a date, a date and time, a time and a time stamp data types (date\_time class). We calculated and assigned values to each of the new attributes with respect to (4), (5), (6), (7) and (8) at design time. Thus, the activity component and trip component of the person object behave as totally time ordered sets at run time.

The following seeks to present the design and the implementing of the temporal extension by operationalizing the Allen's temporal predicates [1] and the foregoing time linear sets properties.

## **Modeling and implementing the temporal query extension**

The temporal query extension is supposed to manage temporal topology queries. For the ABTB, temporal topology includes the temporal relationships and the temporal functions related to ordinal positioning of events on a time line. Thus, the temporal query extension is bicephalous. The first part consists in the mapping of the temporal relationships as formalized by temporal logic predicates [1]. The second part involves the design of event chain query functions and their mapping into position operators.

### **Allen's temporal predicates**

The temporal relationships are shown in Figure 5. Their representation in the form of temporal predicates is shown in Table 1.

To implement the temporal predicates, we wrapped a set of methods around the Predicate class from the Smallworld Magik language class library. These methods are added as an extension to a specific class in the Magik class library hierarchy, namely the data Collection class, in a way that the methods are automatically inherited by its runtime instance classes. These methods target temporal objects such as trip or activity taken as independent objects or as components of the person object. The newly added time structures (event start time and event end time) are included as parameters into the method signatures. Once embedded into queries, the methods act like relational query selection retrieving temporal result sets that can be empty,

singleton or having multiple elements. This means that they are not suitable to build queries which goal is to retrieve specific objects located at specific positions in an ordered collection of objects. In fact, we need a set of functions that target the ABTB event chains and can retrieve only empty or singleton result sets. That is the subject of the following section.

### **Event chain query operators**

The specifications of the prototype and the scientific expectations of the project stress on the need of navigating through the instances of events to trace back moves, activities and their chaining in a individual temporal path. For this task, we had to model the atomic access operators to a specific value at a specific position.

### **Trip and activity event positional operators**

As showed in (4), (5), (6), (7) and (8), activities and trips constitute totally order sets (linear sets). For this category of sets, we use a list access modeling approach that retrieves elements based on a list index, which is the positional function from the index set on the list set. We introduce the following truth values to characterize this function. Figure 6 illustrates some of its instances.

For  $A$  as a totally ordered set of activities, let's assume that  $\langle A, i \rangle$  is true if there is a value at the  $i$  position of the activity event set. This value is denoted by  $A[i]$  (or  $E_i$ ) otherwise  $\langle A, i \rangle$  is false (or  $E_i$  does not exist). For each  $\langle A, i \rangle$ , we define an operator  $\eta$  which retrieves the next element in the event chain.  $\eta A[i]$  is true if for  $1 \leq i < n$ ,  $\exists A[i+1]$ . In other terms, for an  $E_i$ , there is an  $E_{i+1}$ . This operator is always false when  $n \leq i$ . For each  $\langle A, i \rangle$ , we define an operator  $\pi$  which retrieves the previous element in the event chain.  $\pi A[i]$  is true if for  $1 < i \leq n$ ,  $\exists A[i-1]$ . In other terms, for an  $E_i$ , there is an  $E_{i-1}$ . This operator is always false when  $i = 1$ .

We also define other classical chain operators.

$\text{First}() = \alpha A = A[1]$  is always true for  $A \neq \emptyset$ . It returns the first event in the chain,  $E_1$ .

$\text{Last}() = \omega A = A[n]$  is always true for  $A \neq \emptyset$ . It returns the last event in the chain,  $E_n$ .

$\text{Nth}() = \chi A = A[\text{nth}]$  is always true for  $1 \leq i \leq n$ . It returns the  $\text{nth}$  event in the chain,  $E_{\text{nth}}$ .

$\text{Count}() = \Sigma$  returns the count of events in a chain of events.

These operators are also valid for  $M$  as a totally ordered set of trips. We implemented these operators as methods which are listed in Table 2.

The third column of the table points out to the object that owns the method and can fire it from any of its instances.

### Time path event positional operators

As proposed by (10) and (11), the time path is a totally ordered combination of trip and activity time ordered events. We started by implementing a method at the person object level to build the individual time path. This construct becomes the target of a set of positional operators. Figure 7 shows some of these position functions.

For  $P$  as a time path, let's assume that  $\langle P, i \rangle$  is true if there is a value at the  $i$  position of the time path event set. This value is denoted by  $P[i]$  (or  $E_i$ ) otherwise  $\langle P, i \rangle$  is false (or  $E_i$  does not exist). For each  $\langle P, i \rangle$ , we can define an operator  $\eta$  which retrieves the next element in the event chain.  $\eta P[i]$  is true if for  $1 \leq i < n$ ,  $\exists P[i+2]$ . In other terms, for an  $E_i$ , there is an  $E_{i+2}$ . This points to the next event of the same kind (similar) in the time path chain. Because trips and activities are intercalated, the index should move forward two positions starting from the current position  $i$ . This operator is always false when  $i + 2 > n$ .  $\eta P[i]$  is true if for  $1 \leq i < n$ ,  $\exists P[i+1]$ . In other terms, for an  $E_i$ , there is an  $E_{i+1}$ . In this case, the identity of the next event is a trip event if the current  $P[i]$  is an activity event and vice versa. This operator is always false when  $n \leq i$ .

For each  $\langle P, i \rangle$ , we can define an operator  $\pi$  which retrieves the previous (similar) element in the event chain.  $\pi P[i]$  is true if for  $2 < i \leq n$ ,  $\exists P[i-2]$ . In other terms, for an  $E_i$ , there is an  $E_{i-2}$ . This points to the previous event of the same kind (similar) in the time path chain. Because trips and activities are intercalated, the index should

move backward two positions starting from the current position  $i$ . This operator is always false when  $n-2 < 2$ .  $\pi P[i]$  is true if for  $1 < i \leq n$ ,  $\exists P[i-1]$ . In other terms, for an  $E_i$ , there is an  $E_{i-1}$ . In this case, the identity of the previous event is a trip event if the current  $P[i]$  is an activity event and vice versa. This operator is always false when  $i \leq 1$ .

We also define other chain operators dedicated to the very nature of the time path. Thus, we can compute the first and the last trip event or the first and the last activity event in the time path.

$\text{First\_event}() = \alpha P = P[1]$  is always true for  $P \neq \emptyset$ . It returns the first event in the time path chain,  $E_1$ .

$\text{Last\_event}() = \omega P = P[n]$  is always true for  $P \neq \emptyset$ . It returns the last event in the time path chain,  $E_n$ .

$\text{Event}() = \chi P = P[nth]$  is always true for  $1 \leq i \leq n$ . It returns the  $n$ th event in the time path chain,  $E_{nth}$ .

$\text{First\_activity}() = \alpha P(A[0])$  is always true for  $\langle P, i \rangle \cap P[i] = \alpha A$ . It returns the first activity event in the time path chain.

$\text{First\_trip}() = \alpha P(M[0])$  is always true for  $\langle P, i \rangle \cap P[i] = \alpha M$ . It returns the first trip event in the time path chain.



$\text{Last\_activity}() = \omega P(A[n])$  is always true for  $\langle P, i \rangle \cap P[i] = \omega A$ . It returns the last activity event in the time path chain.

$\text{Last\_trip}() = \omega P(M[n])$  is always true for  $\langle P, i \rangle \cap P[i] = \omega M$ . It returns the last trip event in the time path chain.

$\text{Count}() = \Sigma P$  returns the count of events in the time path that is the sum of trip events and activity events.

As for the activity and trip sets, we implemented those operators as methods at the person, the activity and the trip object levels. Thus, it can be fired by any of these object instances. Table 3 shows the method list.

The third column of the table points out to the object that owns the method and can fire it from any of its instances. The person owned methods are in fact a re-use of the trip and the activity owned methods via the dotational notation. For example, the *person.trip\_previous\_activity(position, target)* method can be rewritten as follows: *person.trip(position).previous\_activity(target)*. The first formulation is semantically close to the time path concept. The second is more elegant.

In addition, we implemented a set of utility methods that retrieve events on the basis of the event purpose or mode given as parameter as in Table 4. These methods return one of three classes of results:

a specific trip or activity can be fetched using its transportation mode or purpose such as in *trip\_with\_mode(string)*. This method retrieves the first occurrence on the

time path of the trip object having the mode defined by the value of the string parameter.

sets of activities or sets of trips occurring before or after an activity or a trip having a specific mode or purpose.

sets of events occurring before or after an activity or a trip having a specific mode or purpose.

## **Results**

In order to illustrate the behavior of the temporal query extension, we present examples including: 1) the implemented Allen's temporal predicates, 2) the implemented event chain positional operators, and 3) a graphical depiction of a time and a spatial path. For instance, requests to the database prototype use a textual interface that respects dotational formalism. Thus and for the demonstration clarity, we employ UML (Unified Modeling Language) sequence diagrams formalism [3] to represent their respective strings. These diagrams are read horizontally from left to right and vertically from top to bottom. The squares represent objects and arrows represent methods and messages.

### **Allen's temporal predicate examples**

Figure 8 shows the implementation of Allen's meets predicate as a method inherited by the activity object from a Smallworld GIS Magik parent class e.g. the

dd\_collection\_mixin class. In dotational terms, the query sentence is formulated as following: *activity.meets(start\_time, end\_time)*. The activity object which refers to a collection of activity instances fires the method *meets()* recursively. If it is not empty, a result set containing all the activity instances, which match the temporal parameters included in the method signature, is expected to be returned.

Figure 9 shows the implementation of the overlaps predicate at the person object level. In dotational terms, the query is formulated as follows: *person.trip\_list().overlaps(start\_time, end\_time)*. The person refers to an instance of the person object. The *trip\_list()* method initiates the trip component of the person. The trip component fires recursively the *overlaps()* method and retrieves the trips where temporal attributes match the *overlaps()* method parameters and conditions. If the result set is not empty, it is returned to the person object.

### **Event chain query examples**

In this set of examples, we present two queries involving positional operators and a query that combines positional operators and attribute operators.

#### **Trip object querying involving positional operators**

This example looks up to retrieve an activity event that happened previously to a specified trip. In dotational terms, the query is expressed by the sentence :

*trip.previous\_activity(target)*. The *trip* word refers to an instance of the trip object. The *previous\_activity()* method has a parameter that points to a specific activity position on the time path. If this parameter is omitted, the method fetches the first activity before the specified trip.

Figure 10 shows the sequence of methods fired by the query. The trip object retrieves the person object that made it. The person object constructs its time path. The time path retrieves the activity using a positional operator method (*nth\_activity\_event()*) to which the *target* parameter is bound. If found, the activity instance is returned to the trip object.

### **Person object querying involving positional operators**

In this example, the person object is looking for the trip event, which follows a specific activity. In dotational term, the query is expressed by this sentence: *person.activity\_next\_trip(position, target)*. The *person* refers to an instance of the person object. The *activity\_next\_trip(position, target)* method has two parameters. The first refers to the position of the activity. The second refers to the searched trip position.

Figure 11 illustrates this query. The person object reconstructs its activity component through the method *activity\_list()*. A specific activity is selected because of the position parameter. This activity asks itself for the next trip event. This method

constructs the person time path. The time path fires a method (`nth_trip_event()`) that selects the trip which position matches the target parameter value. The trip is returned to the person object.

The `nth activity event()` and `nth_trip_event()` methods refer to a generic set of conditional statements used to get a handler over specific objects on the time path. Their parameters depend on the time path size, the parameter target value, and its comparison with the time path positional operators as shown in Figure 7.

### **Query with reference to trip mode involving positional and attribute operators**

Comparatively to the time path event queries, which are functions that return a singleton or an empty set, this example is a normal relation expected to return an empty set, a singleton or a multiple elements set. In dotational terms, the sentence is written as follows: *person.activity\_before\_trip\_mode(mode)*. The person word refers to an instance of the object person. In Figure 12, the person object fires the `trip_with_mode(mode)` method to retrieve the first occurrence of a trip having a mode equal to the mode parameter. This initiates the time path which tracks the first trip with the specified mode and returns the `trip_index` to the person. The person fires `activity_before_event()` method, which sends `event_before()` message to the time path object. A collection of event objects that have an index position lesser (before) than the `trip_index` activity is extracted from the time path. This extracted collection

queries itself about activity events. If activity events are found in the collection, an activity result set is returned to the person object.

### **Depiction of a person space-time path**

In this example, we used the time path to create a day behavior report that lists all the trip and activity events performed by a person during a day (Figure 13). In addition, we used it to depict its spatial counterpart on the activity places and road network map (Figure 14) as a way to link the time path to the space path.

Figure 13 shows an individual time path. The first column displays the event order in the time path and shows the trip and activity event intercalation and succession. The second column displays the event class. The third column displays the event identity number. The fourth column is shared between trip and activity events. If the event is a trip, the column shows the trip transportation mode (C for car driver, P for a car passenger, M for walking, T for Taxi, V for Bicycle and Q for Bus and A for other). If it is an activity event, it displays the activity purpose (T for work, D for home, E for academic activity, L for entertainment, M for shopping and A for other). The fifth column is also shared by the trip and the activity event. If the event is a trip than the column displays the postal code of the origin of the trip. If the event is an activity, the column displays the postal code of its location. The last two columns show the event temporal attributes. They are organized in respect to the constraints of the time path

definition as a totally ordered set. The time granularity of both columns is hours/minutes. Seconds are ignored.

Figure 14 reveals the spatial counterpart of the time path. The characters refer to the activity types. The circles with numbers refer to the succession numbers of trips and activity as they appear on Figure 13. Thus, the person makes a first trip at 7:30 (1). She arrives at her work place (T) at 7.33. She stays at her work place until 15:59 (2). Then she makes her second trip (3) to her home (D). She arrives at 16:04. She stays at home until 18:44 (4). Then, she makes her third trip (5) to an academic place (E) where she stayed until 21:14 (6). In a final trip (7), which starts at 21:15, she returned back home (D) where she stayed until 12:29 of the next day(8). We notice that all the trips are made by driving a car ( Mode C).

As illustrated, the time path can be linked to the space path. Together, they constitute the space-time path. In the next section, we will discuss the overall results of this phase of the project and portray its afterwards steps.

## **Conclusion**

To transform a static database prototype to a temporal one, we used design protocols as presented in the temporal database literature. We modified the database schema by adding time interval attributes that delimit the temporal boundaries of events. We developed a set of methods inspired by the relational calculus proposed by Allen's

temporal predicates [1]. Henceforth, ABTB time tagged objects such as trip object and activity object can seamlessly answer temporal queries.

Meanwhile, we noted that even if these protocols are well suited for developing and querying standard temporal databases, they do not address the space-time path as the main analysis unit in the ABTB domain. The space-time path is a run time object composed of trips (with their itinerary and their spatial representation by road segments), and activity objects (with spatial locations where they were performed) accomplished by an individual. This construct is crucial to the ABTB because it represents the individual trajectory as an historical behavior. The historical dimension is important to achieve scientific understanding, prediction, explanation, learning new rules from recurrent facts, and for planning.

To solve this problem, we modeled the trip and the activity components of the person object as a totally time ordered sets. Thus, we embedded the time order into the components. The intersection between these sets is an empty set excluding overlapping between component time intervals. By their union, the components constitute the time path which is also a totally time order set. The handling of the space part of the path is left to the standard network analysis tool of the host GIS shell.

As sets, the linearly ordered trip component, activity component and the time path can be searched using their respective indexes. We designed a set of positional



operator methods that transform temporal queries into retrieval functions based on set ordering indices. Taken together, the two sets of methods compose a bicephalous temporal query extension. As demonstrated in the foregoing result section, the idiosyncrasy of the extension shows the expected behavior.

The database prototype meets the main objective of the study. It permits the retrieval of disaggregate travel behavior past event chaining. The historical knowledge helps identifying the recurrent events and serves as a fundamental basis for searching travel behavior patterns. This prototype can eventually be transformed into a simulation tool, the actual status is at the very basic level. Our intensive use of the object-oriented paradigm that was designed primarily for simulation ([5],[6]) helped us produce a prototype where objects behavior are easily modifiable to include travel behavior constraints and consequently to show autonomous travel decision making.

The query extension we developed reveals some limitations when challenged with complex *ad hoc* queries. To deal with this kind of query, the legitimate reaction is to add new methods to the extension to meet the needs of the *ad hoc* query. However, this approach is not suitable if we consider the number of methods that should be added each time a query of a certain level of complexity is formulated. Additionally, the extension lacks a method that compares two or more time paths. The comparison may be implemented as an intersection between different sets. Using the Allen's predicates, the intersecting operation can be expressed as an iteration which takes each event from the first time path set and apply against it the disjointure of the

following predicates (during, overlaps, starts, finishes, equals) using respectively each of the events of the second time path as parameter. This method should be implemented in an advanced version of the prototype.

## **Acknowledgements**

This research was funded by the Natural Science and Engineering Research Council (NSERC) through a grant awarded to Danielle Marceau and the Network of Centres of Excellence in geomatics (GEOIDE). Authors are grateful to the Society of Transportation of the Urban Community of Quebec City (STCUQ) and the Ministry of Transportation of Quebec (MTQ) for the access to disaggregate OD survey data.

## References

1. J. F., Allen. "Towards a general theory of action and time," *Artificial Intelligence*, Vol. 23:123-154, 1984.
2. K. Al-Taha, R. T. Snodgrass and M. D. Soo. "The Tempis project, bibliography on spatiotemporal databases," Department of Computer Science, University of Arizona, Tempis Technical Report, No. 44, 1993.
3. W. Boggs and M. Boggs. *Mastering UML with Rational Rose*. Sybex: San Francisco, CA, 1999.
4. M. H. Bohlen. "Temporal database system implementation," *Sigmod Record*, Vol. 24(4):53-60, 1994.
5. O-J. Dahl and K. Nygaard. "SIMULA-An ALGOL-based simulation language," *Communications of the ACM*, Vol. 9:671-678, 1966.
6. O-J. Dahl, B. Kyhrhoug and K. Nygaard. "The Simula 67 common based language," Norwegian Computer Center, Oslo, Publication S22, 1970.
7. A. Frihida, A., D. J. Marceau and M. Thériault. "Spatio-temporal object-oriented data mode for disaggregate travel behavior," *Transactions in GIS*, accepted for publication, 2001.
8. R. G. Golledge, M. P. Kwan and T. Garling. "Computational process modeling of household travel decisions using a geographical information system," *Papers in regional science*, Vol. 73(2):99-117, 1994.
9. S. Greaves, and P. Stopher. "A synthesis of gis and activity-based travel forecasting," *Geographical Systems*, Vol. 5:59-89, 1998.

10. T. Hägerstrand. "What about people in regional science?," *Papers of the Regional Science Association*, Vol. 4:7-21, 1970.
11. S. Heyward. *Computers for animation*. London:Focal Press, 1984.
12. C. S. Jansen, J. Clifford, S. K. Gadia, and R. T. Snodgrass. "A glossary of temporal database concepts," *Sigmod Record*, Vol. 21(3):35-53, 1992.
13. C. S. Jensen and R. T. Snodgrass. "Temporal data management, Institute of Information Systems," TimeCenter, Zurich, Technical Report TR-17, 1997.
14. M. Kwan. "Space-time and integral measures of individual accessibility: A comparative analysis using a point-based framework," *Geographical Analysis* , Vol. 30(3):191-216, 1998.
15. M. Kwan. "Gisicas: An activity-based travel decision support system using a GIS interfaced computational-process model," In Ettema D and Timmermans H (eds) *Activity based approaches to travel analysis*. Elsevier Science ltd: UK, 263-282, 1999.
16. M. Kwan and X. Hong. "Network based constraints oriented choice set formation using gis," *Geographical Systems*, Vol. 5:139-162, 1998.
17. B. Lenntorp. "A time-geographical simulation of activity programs," In T. Carlstein , D. Parkes and N. Thrift (eds) *Timing Space and Spacing Time*, Vol. 2: *Human Activity and Time Geography*. Edward Arnold Ltd: London, UK, 1978.
18. J. Makin, R. G. Healey and S. Dowers. "Simulation modelling with object-oriented GIS: a prototype application to time geography of shopping behavior," *Geographical Systems*, Vol. 4(4):397-429, 1997.

19. M. G. McNally. "Activity based forecasting models integrating GIS," *Geographical Systems*, Vol. 5:163-187, 1998.
20. H. J. Miller. "Modelling accessibility using space-time prism concepts within geographical information systems," *International Journal of Geographical Information Science*, Vol. 5(3):287-301, 1991.
21. H. J. Miller. "Measuring space-time accessibility benefits within transportation networks: Basic theory and computational procedures," *Geographical Analysis*, Vol. 31(2):187-212, 1999.
22. H. J. Miller. "Potential contribution of spatial analysis to geographic information systems for transportation (GIS-T)," *Geographical Analysis*, Vol. 31(4):373-409, 1999.
23. D. O'Sullivan, A. Morrisson and J. Shearer. "Using desktop GIS for the investigation of accessibility by public transport: an isochrone approach," *International Journal of Geographical Information Science*, Vol. 14(1):85-104, 2000.
24. D. Peuquet. "It about time: A conceptual framework for the representation of temporal dynamics in geographic information systems," *Annals of the Association of American Geographers*, Vol. 84(3): 441-461, 1994.
25. R. T. Snodgrass. "Developing time-oriented database application in SQL". Morgan Kaufman Publishers: San Francisco, CA, 2000.
26. M. Thériault, D. Leroux and M. H. Vandersmissen. "Modelling travel route and time withing GIS: its use form planning," In A. Bergelia, E. Kerckhoffs (ed.) ESS'98,

The 10th European Simulation Symposium (October 26-28, 1998). Society for Computer Simulation International:Netherlands, 402-407, 1998.

27. M. Thériault, and C. Claramunt. "La représentation du temps et des processus dans les SIG: Une nécessité pour la recherche interdisciplinaire," *Revue Internationale de Géomatique* , Vol. 9(1):67-99, 1999.

28. V. J. Tsotras, A. Kumar. "Temporal database bibliography update", *Sigmod Record*, 25(1):41-51, 1996.

29. W. G. M. Van der Knaap. "Analysis of time-space activity patterns in tourist recreation complexes, a GIS oriented methodology," In Ettema D, Timmermans H (eds) *Activity based approaches to travel analysis*. UK, Elsevier Science ltd:UK, 283-311, 1999.

30. M. Wachowicz. "Object-oriented design for temporal databases" Taylor and Francis: London, UK, 1999.

31. D. Wang and T. Cheng. "A spatio-temporal data model for activity-based transport modeling," *International Journal of Geographical Information Science*, Vol.15:561-585,2001.

Le second chapitre décrivait le cadre théorique et la méthodologie utilisés pour le design et l'implantation des requêteurs temporels et positionnels. Le troisième chapitre expose l'approche adoptée afin de concevoir et implanter une interface expérimentale qui automatise la formulation des requêtes et l'affichage des résultats sous forme tabulaire ou sous forme graphique statique et animée.



## **Chapitre III- Q&V: An Experimental Interface to Query and Visualize Activity-Based Travel Behavior Data**

Ali Frihida\*

[REDACTED]

Danielle J. Marceau\*

[REDACTED]

Marius Thériault\*\*

[REDACTED]

\*Geo-Computing Laboratory, Département de Géographie, Université de Montréal

\*\*Centre de Recherche en Aménagement et Développement, Université Laval

Cet article sera soumis à la revue *Cartography and GIS*.

## **Abstract**

Depiction of individual travel behaviour dynamics can be achieved by the production of spatio-temporal data sets and their transformation into graphical animation on a street network map. To produce spatio-temporal data sets, a geographic information system (GIS) database should have temporal querying capabilities. To depict movement, a graphical tool is needed. In this paper, we describe the design and development of an experimental user interface that enables an easy temporal querying and the depiction of individual movements on an urban street network using a cast-based cartographic animation. The interface lays on the top of a temporal GIS database prototype. The GIS database is populated with samples of disaggregate origin-destination survey data, street network, homes and activity places. Prototyping area is located in the Quebec City metropolitan area, Canada. The new prototype can sustain seamless spatio-temporal queries and animate individuals on a static background with visual discrimination between transportation modes and trip purposes.

**Keywords:** Temporal GIS, temporal query, graphical interface, graphical depiction, cartographic animation, cartographic visualization, disaggregate travel behaviour

## **Introduction**

The interest in the disaggregate travel patterns is rejuvenated by the new emerging social structures and the political focus on micro-level behavior as a way to optimize the existant resources. The ongoing origin-destination studies conducted to gather travel data materialize this shift by a “desertion” from the zonal aggregated trip approach and models to a finer scale approach where the individual behavior data are collected and scrutinized using micro-simulation models. Between the data collection and the data analysis lays a crucial step where collected data are converted into a database. This conversion should keep intact the representational intention of the survey as it covers quantitatively and qualitatively what is considered as the necessary dimensions of the observed domain. The database technology is assumed to render a domain as-it-is in reality and to permit an easy manipulation of its content. In our study, we proposed an approach that emphasises 1) the critical importance of the database data model as a mapping of the spatio-temporal activity-based travel behavior (ABTB) semantics, and 2) the crucial role the data representation formalism plays in this mapping.

In Frihida et al. (in press), we proposed a spatio-temporal data model which renders the semantic richness of the ABTB. The data model is built through the analysis of data samples drawn from a disaggregate Origin-Destination survey conducted in 1991, a street network, homes and activity places located in the Quebec City metropolitan area in Canada. In this model, the person (commuter, individual) is considered the atomic (indivisible) component as it plays an axial role in the

configuration of ABTB universe of discourse. The person role is defined by its trips and its activities during a journey cycle where he/she trades his/her time into space (Figure 1).

The time for space trading is controlled by constraints such as the available time, desire to participate in activities, household type, transportation facilities and institutional work hours. The obtained space may be in the form of accessible road network trunks (during a trip) or activity places (during activity performing). In other terms, in addition to his/her socio-demographic characteristics, the person is associated to a space-time path which is defined by his/her daily transaction log as a memory of the transportation related events he/she participates in (Figure 1). Consequently, the person travel behavior basic data are re-created in the form of a space-time path which is in fact the main analysis unit of the ABTB.

This ABTB vision which is largely inspired by the time-geography framework (Hägerstrand 1970, Lenntorp 1978) should be transformed into a data model that reproduces the axial role of the person. Because it is said to represent the complexity of real world entities as they are perceived by humans, we employed the object-oriented paradigm and its object metaphor as a representation tool. As shown in Figure 2, the data model implemented the ABTB entities as objects linked by meaningful associations. Trip, activity, activity plan and scheduling entities were modeled as objects where time is orthogonal. The person entity was modeled as an aggregation of these objects from which it inherits temporality.

With this design, the person object reproduces the person as it was defined in the ABTB domain. It has an active “memory” that is able to trace back past events and re-build the space-time path. This ability is praised by researchers because it offers the possibility to analyse the past and ultimately helps in forecasting and simulation.

The object-oriented spatio-temporal data model was implemented into the Smallworld GIS 3.1 SP2™ shell to obtain a proof-of-concept database prototype. The prototype reproduces the semantic richness of the spatio-temporal data model and offers a means to navigate through a nested hierarchy of objects, providing a description of an individual’s travel behavior over space and time. But the prototype does not provide tools to temporally query the database in order to trace back events and to re-construct the space-time path. The main reason of this shortcoming is the static nature of GIS shell that hosts the prototype which is devoid of temporal reasoning and querying capabilities.

In Frihida et al. (2002), we adressed this shortcoming by transforming the static database into a temporal one. This transformation affected the database schema and the query engine, and was made with the space-time path as the ABTB analysis unit. Using the set theory, we defined an ABTB abstract temporal atomic event. Each temporal event is defined by a starting time and an ending time drawn from the Cartesian product of the application time ( $T^2$ ). The starting time is always prior to the ending time. This atomic event was used to produce the activity event chaining and the trip event chaining as a totally time ordered sets which are irreflexive, non-

symmetric and transitive. We stated that the intersection of the activity time ordered set and the trip ordered set is an empty set. Moreover, we stated that the union of these sets constitutes the time path (the space part is managed by the Smallworld GIS network analysis tool). As a totally ordered set, the time path is non-reflexive, non-symmetric and transitive. In the time path, the trip events chaining and the activity events chaining are intercalated. Each trip event is followed by an activity event and vice-versa (Figure 3a). Even if the modeling scope does not cover cases such as a chaining of two or more consecutive events of the same class (trip or activity), the actual definition of the time path avoids person ubiquity and consequently temporal incoherence.

To implement this modeling, we embedded the atomic event definition into the database schema. Thus, for the trip object, we added an end time stamp attribute because the O-D survey encoded only the start time stamp. Since the activity object is an *ex-nihilo* object, absent from the survey data, we added to its structure a start time attribute and an end time attribute. We also added a duration attribute which holds the difference between the end time attribute value and the start time attribute value to both of them. We computed the values of the new added attributes at design time. To exploit the new added attributes, we implemented the temporal predicates defined by Allen (1984) as a set of methods. This set of methods constitutes a temporal query extension that enhances the prototype by temporal reasoning capability. The end result of the database schema alteration is a temporal GIS prototype that meets the standards of the temporal databases as discussed in Snodgrass (2000). However, the

temporal prototype lacks a tool that handles topological queries addressed to the trip and activity event chaining and to the time path. To resolve this, we designed and implemented a temporal extension as a set of methods that permit to retrieve specific event position relative to another specific event or at a specific position. Thus, the Allen's predicates based extension and the position-oriented query extension allow the prototype to act as a spatio-temporal data server dedicated to the ABTB domain.

For instance, the space time path can be deduced from activity and trip event chaining and displayed in a tabular alphanumeric format. Even if the tabular format has some visual utility, it can not substitute a graphical representation on a map. The graphical representation supposes the projection of the space time path as a 3-D entity (x,y coordinates and z time) on a 2-D plane (x,y coordinates). By truncating the space time path z dimension, the projection process converts space time path into a purely spatial entity encompassing the visited road segments and activity locations. Void of temporal dimension, the graphical depiction has a limited expressive power. In fact, the projection process reproduces the a-temporality as one of the main weaknesses of the current generation of GIS. To overcome this shortcoming, we intend to re-introduce the temporal dimension process of the time path on the graphical map. The temporal dimension re-habilitation is not concerned by the temporal properties of the trip or the activity object but by the trading process of time for space. This trading process will be expressed visually by cartographic animation.

To achieve this task, we need to solve two major problems:

- (1) Smallworld GIS™ palette and icons library is far from being rich. To implement cartographic animation, we need to develop a set of symbols that visually permit to distinguish between different trip modes and different activity purposes. In order to efficiently use these symbols to represent activity types or to trace-out a trip itinerary, these symbols should be controlled by a set of coded procedures.
- (2) the temporal query extensions interface is text-based. Querying trip, activity and time path is not straightforward. The user needs to have an expert knowledge of the Magik language (Smallworld GIS™ object-oriented language) and the methods associated with the temporal extensions to formulate well-formed queries. To overcome this obstacle, we considered the temporal query extensions methods set as an API (Application Programming Interface) which functions can be activated through a graphical interface using a point-and-click approach.

Moreover, the same interface can be useful to integrate the temporal query extensions and the cartographic animation procedures in such a way that the result sets produced by temporal querying can become the input for the animation and displaying procedures.

In this paper, we describe a graphical interface that permits to query person, trip activity and time-path objects using the temporal extension and to dynamically depict space-time path of individuals. The first section presents a brief state of the art of the



cartographic animation research field. The second section describes the methodology we used to design meaningful symbols to represent locations and itinerary and to implement cartographic animation, and the Microsoft Visual Basic™ based interface we developed. In the third section, we discuss the behavior of the interface by presenting temporal query examples and depiction.

### **Brief state of the art in cartographic animation**

To depict individual disaggregate travel behaviour, map animation is an appropriate technique. It can serve to further travel behaviour exploration, discover its processes, and visualise its dynamics through revelation of its embedded space-time paths. To achieve animation, a temporal GIS, a set of graphical symbols representing static and dynamic visual variables and a set of animation scripts are needed. Temporal GIS is characterised by a query engine that sustains seamless spatio-temporal queries.

Cartographic animation represents the shift made by cartography from a *communication* paradigm to the *analytical* or *holistic paradigm* following the wide spread use of computer technology (Tobler, 1959, Demers, 1997). Maps become less a final product and more a flexible tool employed in fields such as spatial data communication and analysis, scientific visualisation and scenario simulation (Tobler, 1973; Moellering, 1980; Campbell and Egbert, 1990; Dorling, 1992; Dibiase et al., 1992; Peterson, 1994; Kraak et al., 1995). For a comprehensive review of the developed applications, the reader is referred to Jomier et al. (2000) and Raper (2000).

To represent geographic objects, the traditional cartography uses the visual variables related to point, line, area and volumetric symbols (Bertin, 1981, 1983; Robinson et al., 1995, Muehrcke and Muehrcke, 1998). In order to accommodate cartographic animation, the visual variable set is reviewed to include position, speed, viewpoint, distance and scene variables (Hayward, 1984). This enhancement permits to modify at run time the visual and locational characteristics of animated objects on the basis of data content retrieved from computer database.

Technically, the temporal animation can be frame-based or cast-based (Peterson, 1994). The first technique consists of the creation of a set of map frames that are quickly displayed to mimic movement. The cast-based animation refers to a foreground cell (sprite or symbol) moving on a fixed background. This technique implies coding procedures that control the symbol movement (Monmonier, 1992).

In the following section, we describe the methodology we used to design and develop a spatial dynamic depiction tool to visualize individual space-time paths.

## **Methodology**

### **Symbol set and animation procedures development**

Our prototype is hosted by the Smallworld GIS<sup>TM</sup> shell. This shell offers an object-oriented GIS application development environment which is suitable to map the object-oriented data model we designed into a database prototype. To implement the

objective requirements, we adopt the incremental prototyping strategy. Thus, our actual prototype is the starting milestone for the modifications we intend to make.

Our application depicts movements of individuals on a road network. This depiction is a graphical representation of space-time paths. The space-time path embodies a rational use of a time budget to realise a set of scheduled activities under different constraints. To efficiently render a space-time path, appropriate visual variables and animation technique to display them to the end user should be chosen.

The individual movement involves the depiction of the trip path and the location of the performed activities. The trip path starts from an origin (activity) location and goes through the street network to the destination (activity) location. The trip is made using transportation mode and is in pursuit of an objective (purpose). The activity is defined by the purpose of the trip. Hence, to visually distinguish between different trips, different styles should be allocated to each category of modes and to each category of purposes.

To create a cast-based animation, a static background and a moving symbol are needed. For our application, the map (street network and activity places) is used as a static background. To render the movement, point symbol and line symbol are the options. The point symbol is excluded because the map road segments are not represented by the same number of coordinates. This disparity leads to an animation where point symbols “jump” when moving from a coordinate to a distant one. Re-

drawing gradually the trip itinerary segment using the line symbol renders a smooth animation. To offer a comfortable movement to the human eyes, the speed of the animation can be controlled by modifying the computer drawing speed. Thus, animating a walking individual will take more time than animating a driving individual. This scalable animation can consider other factors such as legal or recurrent speed limits of the itinerary segments.

We designed the line style as being dependent on the trip mode. For example, if the trip mode is walking then the line style is thinly dashed. By contrast, a trip made by personal vehicle is using a thick line style. To depict the activity performed at the end of a trip, each location (activity places) is re-drawn using a specific symbol representing the purpose.

Because purposes and modes are orthogonal to the line drawing, we combined both of dimensions into a style allocation matrix as shown in Table 1.

All the cast-based animation is established upon an utility set of procedures that compose the depiction tool. The set is made of three categories of procedures developed using the Smallworld Magik language:

- (1) Data collection procedures whose role is to identify the space-time path as an aggregation of references to physical road segments, the transportation mode used to make the trip, the purpose of the trip, and the origin location and destination location of the trip

- (2) Space-time path depiction procedures whose role is to use the collected data from the previous step and perform the following tasks: consult the style allocation table to pick the appropriate style for the transportation mode and the activity place, use the chosen style for the transportation mode, gradually draw each space-time path segment by segment, and finally use the style for the activity place to re-draw the activity place where an activity is performed.
- (3) Speed control procedure whose role is to assign a drawing speed to the drawing symbol according to its mode.

The cast-based animation needs spatio-temporal data sets as an input to its expected behavior. In the following, we describe the interface we developed that links the graphical depiction tool to the temporal query extensions.

### **Graphical interface development**

The graphical interface is developed using the Microsoft Visual Basic™ environment. The choice of the Visual Basic™ is driven by the aim to create an interface with a high level of ease-of-use and conviviality. Since the database prototype has text-based interface, the formulation of a temporal query or the depiction of a space-time path need several Magik lines in addition to a precise knowledge of objects attributes, methods and depiction procedures. With the interface, we intend to substitute sequences of mouse selection and click to the text-based interface. This substitution will hide the complexity of query formulation and graphical depiction by offering a set of controls such as dropdown list or combo box with options from which the user

can select to incrementally build his/her query and depiction task. This transparency offers a seamless exchange between the ABTB database prototype and the end user.

In fact, the development is a tight coupling between Smallworld GIS™ and the Visual Basic™ interface around the database prototype. To facilitate this coupling, we use the Smallworld Automation Server (SAS). The SAS implements Microsoft COM™ (Component Object Model) automation protocol standard. These protocols allow developers using a third-party language such as Visual Basic™ to write applications that will access Smallworld datastore and functionality.

The interface design takes into consideration that the ABTB database prototype owns a large set of methods and procedures that allows to query objects about their temporal properties, to display and to animate them. The interface offers a new way to exploit these resources by making them available through a handle over the Smallworld GIS™ Application Environment. Thus, the interface assumes the prototype methods and procedures as an API collection of routines. During an interface session, these routines will work just like any other Visual Basic™ application routine.

To supply the quality of service anticipated by the interface, we implemented a set of routines that manages the control events and behavior, validates the user's choice, submits the choice to the ABTB application, and retrieves the results. These routines are mouse event driven. The result set manipulation can be in the form of a tabular

display on the interface grid, or of a tabular display on the interface grid augmented with a graphic depiction on the Smallworld Main Graphic Window. The second type of manipulation calls the set of procedures that composes the interface depiction tool.

The temporal query extensions we added to the database prototype (Frihida et al., 2002) showed the need to an integrative query engine that acts as a standard query engine, and as an object-oriented query engine. The standard one manages standard relational algebra and calculus operations for spatial and a-spatial entities. The object-oriented query engine manages the message exchange between the application objects and the returned results. For the standard query computation, an object can be represented by a database tuple as long as the object identity is preserved. By contrast, the tuple representation is excluded when methods associated with the behavior of an object should be fired. Accordingly, the interface must be able to establish a querying strategy that treats the object as a tuple when a standard query is formulated and as an object when the object is the target of a message.

We implemented a simple sequential piping solution to process query sentences that include a selection and message sending. Its *modus operandi* is as follows. The selection query is intercepted, parsed and submitted to the database prototype. If the result set is not empty then each of the members of the retrieved collection is given its object status and becomes a server for the client message. The returned result of each message is stored in a collective set that is returned to the interface.

In the following section, we present examples of the behavior of the interface.

## Results

To illustrate the interface behavior as a query and cartographic animation tool, we present two sets of examples. The first are related to the activity object while the second is related to the person object.

### Querying the activity object

The first activity query is: *Which work (T) activities are performed at the activity place "G1V2L8" during the period between 08:00:00 and 20:00:00?*

To submit this query, the user needs 1) to check the select group checkbox, 2) to create a selection query which constraints are the activity type and the activity place location using the field list, the operators and the values as given by the query, 3) to choose the message "during" from the combo box on the Allen's predicate panel and fill the time interval fields with the period time stamps, (the time interval fields appear automatically if the during message is selected ), and 4) to click on the button labeled Seek on the Allen's predicate panel.

The result set of the selection query will be displayed on the list box control on the selection panel. If the result set of the temporal query is not an empty set, it will be



displayed on a grid at the bottom of the window. Figure 4 shows the interface window after submitting the query.

The second activity query is given by: *What is the trip that immediately follows the activity 33?*

From the list box of the Selection panel (or from the Activity list box on the left of the Selection panel if enabled), we can double click an element to make it the current value of activity field on the Ordinal Query panel. After checking the Ordinal Query checkbox, the user can choose a positional message from the positional operators list. Once done, he/she clicks on the button labeled “Seek”. Figure 5 shows the final state of the interface after asking the current activity (for instance number 33) to fetch its immediately next trip (*activity.next\_trip* method). As displayed by the grid, the retrieved trip identity number is 15000110. Its origin is the activity place “G1V2L8”. Its destination is the “G1W2L1” which is a home (purpose D). The mode is the car and it took three minutes to reach the destination.

### **Querying the person object**

To illustrate the person querying capability of the interface, we present two examples. The first one concerns a group of individuals and the second focuses on an individual randomly chosen from a list.

### **Group query**

The first group query is: *Find all shopping activities (M) performed by female people having an age greater than 65.*

This means a selection query on person object to retrieve female people with age greater than 65 years. If the result set is not empty, then each occurrence will be sent a message retrieving shopping activity. Figure 6 shows the final status of the interface window after running this query. The result set contains forty (40) occurrences.

The second group query is : *Locate all the places visited by the previous group members.*

To locate the activity places, the user needs to click on the button labeled “Locate All”. This activates the graphical depiction tool. Figure 7 shows the obtained result. The symbol S denotes a shopping activity.

The third group query is: *Fetch all trips made by the previous group that meet the time stamp = 09:33:00*

In Figure 8, the query retrieved two trips that meet the user input.

## Individual query

In this section, we take randomly an individual and query him/her about his/her activities, trips and space-time path. Figure 9 shows the instance, which is selected from the person listbox in the left side of the interface window. It becomes the current person when its identity number is in the person field on the Person Query tab. From this tab, we can already know that the current person has made six activities and an equal number of trips.

The first individual query is: *Fetch the first trip of the current individual.*

From the combo box, the user selects the method *first\_trip()* and clicks the button labeled “Seek”. Figure 9 shows the result of this query.

The second individual query is: *Retrieve the activities performed by the current individual.*

The steps are similar to those of the previous query. But the user must select the method *activity\_list()*. Figure 10 shows the result of this query.

The third individual query is: *What is the third trip after the second activity performed by the current individual?*

This is a topological positioning query of the space-time event chaining. The user needs to select the method *activity\_next\_trip()*. This method signature informs that two parameters are needed. The first one gives the position of the activity. The second points to the position of the target trip. To meet the query constraints, the method must have this form: *activity\_next\_trip(2,2)*. Figure 11 shows the result of this query.

The fourth individual query is: *Fetch the third activity previously to the fourth trip.*

This is also a topological positioning query of the space-time event chaining. The user needs to select the method *trip\_previous\_activity()*. This method signature informs that two parameters are needed. The first one gives the position of the trip. The second points to the position of the target activity. To meet the query constraints, the method must have this form: *trip\_previous\_activity(4,2)*. Figure 12 shows the result of this query.

The fifth individual query is: *Fetch the activities performed by the current individual before 18:00:00.*

This query can be answered by choosing the method *before()*. The time field must have “18:00:00” as a value. Figure 13 shows the result of this query.

The sixth individual query is: *What are the activities and the trips the current individual had made?*

This query refers to the time path. By clicking on the button labeled “Show Diary”, the sequence of events performed by the individual are traced back. The event chaining is re-constructed in respect to the strict total temporal order. The result of the computation is displayed in the grid at the bottom of Figure 14.

The seventh individual query is: *Display the space-time path of the current individual.*

This query calls the procedures related to graphical depiction and cartographic animation encapsulated into the graphical depiction tool. By clicking the button labeled “Depict Path”, the sequence of events as it appears in the previous figure is mapped into graphical symbols on the Smallworld Main Graphic Window. If the event is an activity, a point symbol is picked from the style matrix according to the activity class and attached to the activity place. If the event is a trip, the line symbol is chosen and a line style is assigned to it according to the trip mode. The animation procedures are activated in order to draw progressively the line on the Smallworld Main Graphic Window taken as a static background. The animated drawing mimics the movement of the individual on the street network. Thus, the depiction tool reconstitutes dynamically on a 2-D plane the space-time path including the origin and the destination of the trip in addition to the type of the performed activity. Figure 15

represents the final result of the time path depiction. The H symbol refers to the individual home. The W symbol refers to the workplace.

## **Discussion**

From the result section, we can draw some interesting observations about the interface behavior:

- The interface serves to submit seamlessly spatio-temporal, temporal and positional queries. The query formulation is easy and mostly done by a select-and-click approach. This eliminates the need to code complex Magik language statements as in the text-based interface.
- The interface retrieves the query result sets and displays them automatically in a tabular form. This feature eliminates the need to write Magik iteration procedures to display one by one the result set elements.

The interface permits the static graphical depiction of activity symbols associated with the activity places. Also, it allows the cartographic animation of the movement of the individual on the street network. The graphic rendering is piloted by semantic constraints associated with the activity purpose and trip mode.

Consequently, the interface has glued effectively the temporal and positional query extensions to the graphical depiction tool in such a way that each query result set is a candidate to be the input of the depiction procedures. In fact, this means that the interface is a factory of spatio-temporal data sets that can feed not only the depiction

procedures but other data processing algorithms such as micro-simulation travel behavior data models. Indeed, producing spatio-temporal data infrastructure realizes the main goal of the current study.

Besides these achievements, we notice some shortcomings. In the result section, we avoided to present queries that address the Trip object even if the interface is programmed to do so. The reason is the low quality of the graphical rendering due to line overlapping. In the case where many lines are depicted, the depiction produces messy *spaghetti* like visualization. Moreover, only the color and the symbol of the last drawn trip are kept. This problem is common to the current GIS generation which provides geo-object representation inherited from 2D plane cartography. As a solution, we propose the use of 3D visualization tool to depict each trip on an independent layer allowing the visualization of each trip alone or in-group and from different sides.

The interface permits only the cast-based animation. It could be easily enhanced to produce frame-based animation. This requires the development of procedures that activate temporal and positional methods many times. For example, a procedure that calls the *during* method, assigns to it a period of four hours, runs it against a group of individual and depicts the result. This also needs screen snapshot software that stores the result set depiction in addition to a moviemaker software that takes the snapshots, organizes then into a sequence of frames and plays them.

The interface supports only two level queries. The first level must be a selection query. Queries such as a projection or union are not allowed. The second level must be a temporal query or a positional query. This shortcoming is partly caused by the lack of a powerful query engine which integrates standard query parsing to message handling and formulates a unique query that treats database entities as tuples and objects in the same time. For instance, if we consider an incremental development strategy, the temporal query extension and activity-event chaining positioning extension constitute the starting point to implement the required integrated query engine.

## **Conclusion**

This paper describes the design and the development of an experimental Visual Basic™ interface on the top of a temporal ABTB database prototype host by Smallworld GIS™ . The interface glues two main parts. First, a temporal query extension and an activity-event chaining positioning query extension used to sustain seamless spatio-temporal queries. The second part is a graphical depiction tool that allows: 1) symbol and color assignment to trip and activity according to the transportation mode and activity purpose, and 2) individual space-time path cast-based animation that reveals the itinerary and location and mimics individual movement on the street network. The interface behaves as expected and is intended to be enhanced with more functionalities in order to be useful for urban transportation



decision makers and researchers. The long-term goal is to simulate travel behaviour, explore travel data analytically and predict new urban trends.

## **Acknowledgments**

This research was funded by a grant from the Natural Science and Engineering Research Council (NSERC) awarded to Danielle Marceau and the Network of Centres of Excellence in geomatics (GEOIDE). Authors are grateful to the Society of Transportation of the Urban Community of Quebec City (STCUQ) and the Ministry of Transportation of Quebec (MTQ) for the access to disaggregate OD survey data.

## References

- Allen, J. F. 1984. Towards a general theory of action and time. *Artificial Intelligence* (23):123-154.
- Al-Taha, K., Snodgrass, R. T., Soo, M. D. 1993. The Tempis project, Bibliography on spatiotemporal databases. Tempis Technical Report No 44, Department of Computer Science, University of Arizona.
- Bertin, J. 1983. The semiology of graphics: Diagrams, Networks Maps. Madison: University of Wisconsin Press.
- Bertin, J. 1981. Graphics and graphic information processing, New York: Walter de Gruyter.
- Bohlen, M. H. 1994. Temporal database system implementation. *Sigmod Record* 24(4):53-60.
- Chrisman, N. 1997. Exploring geographic information systems. New York: John Wiley & Sons Inc.
- Campbell, C.S., Egbert, E.L. 1990. Animated Cartography: 30 years of scratching the surface. *Cartographica* 27(2):24-46.
- Demers, M. N. 1997. Fundamentals of geographic information systems. New York: John Wiley and Sons.
- Dibiase, D., Maceachren, A. M., Krygier, J. B., Reeves, C. 1992. Animation and the role of the map design in scientific visualisation. *Cartography and Geographic Information Systems* 19(4):201-204.

- Dorling, D. 1992. Stretching space and slicing time: From cartographic animation to interactive visualization. *Cartography and Geographic Information Systems* 19(4):215-227.
- Frihida, A., Marceau D. J., Thériault, M. in press. Spatio-temporal object-oriented data model for disaggregate travel behavior. *Transactions in GIS*.
- Frihida, A., Marceau D. J., Thériault, M. 2002. Querying travel behavior events : Bringing life into a static GIS. Submitted for publication to Geoinformatica.
- Hägerstrand, T. 1970. What about people in regional science? *Papers of the Regional Science Association* 4:7-21.
- Heyward, S. 1984. Computers for animation. London: Focal Press.
- Jansen, C. S., Clifford, J., Gadia, S. K., Snodgrass, R. T. 1992. A glossary of temporal database concepts. *Sigmod Record* 21(3):35-53.
- Jensen, C. S., Snodgrass, R. T. 1997. Temporal data management, Institute of Information Systems, Zurich, TIMECENTER Technical Report TR-17.
- Jomier, G., Peebocus, M. A., Huntzinger, J. B. 2000. Visualizing the evolution of spatio-temporal objects. In Forer P., Yeh, A. and He, J (eds) *Proceedings of Spatial Data Handling*, 10-12 August 2000, Beijing.
- Kline, N. 1993. An update of the temporal database bibliography. *Sigmod Record* 22:66-80
- Kraak, M. J., Muller, J. C., Ormeling, F. 1995. GIS-Cartography: Visual decision support system for spatio-temporal data handling. *International Journal of Geographic Information Systems*, 9(6):637-645.

- Lenntorp, B., 1978. A time-geographical simulation of activity programs. In Carlstein T, Parkes D and Thrift N (eds) *Timing Space and Spacing Time*, Vol. 2 :Human Activity and Time Geography. London, UK: Edward Arnold. pp. 162-180.
- Moellering, H. 1980. Strategies for real-time cartography. *The Cartographic Journal* 17(1):12-15.
- Monmonier M. 1992. Authoring graphic scripts: experiences and principles. *Cartography and Geographic Information Systems* 19(4):247-260.
- Muehrcke, P. C., Muehrcke, J. O. 1998. Map use: Reading, analysis and interpretation. Wisconsin: JP Publications.
- Peterson, M. 1994. Spatial visualization through cartographic animation: Theory and practice. Online <http://www.odyssey.maine.edu/gisweb/spatdb/gis-lis/gi94078.html>
- Raper, J. 2000. Mutidimensional geographic information systems. London:Taylor and Francis.
- Robinson, A. H., Morrisson, J. L., Muehrcke, P., C., Guptil, S., C. 1995. Elements of cartography. New York: John Wiley and Sons.
- Snodgrass, R. T. 2000. Developing time-oriented database application in SQL. San Francisco: Morgan Kaufman Publishers.
- Tobler, W. 1959. Automation and cartography. *Geographical Review* 49:526-534.
- Tobler, W. 1973. Choropleth maps without class interval. *Geographical Analysis* 5:262-265.

Tsotras, V. J., Kumar, A. 1996. Temporal database bibliography update. *Sigmod*

*Record* 25(1):41-51.

## Conclusion générale

L'objectif de cette recherche était de concevoir et d'implanter une base de données spatio-temporelle pour l'étude du comportement de transport basé sur l'activité. Elle devait être en mesure de modéliser le comportement désagrégé de transport avec un minimum de perte sémantique et ce, par la modélisation des propriétés et du comportement des entités spatio-temporelles et par la modélisation des relations simples et complexes tissées entre les entités. D'autre part, la base de données devait gérer facilement les requêtes spatio-temporelles et permettre l'affichage et la visualisation des ensembles sélectionnés. La base de données devrait servir de fournisseur de données aux modèles de prévision et de simulation du transport urbain.

Pour la conception de cette base de données, nous avons suivi les étapes suivantes :

- (1) Nous avons analysé le domaine de comportement du transport basé sur l'activité dans le cadre de la géographie temporelle. Cette analyse nous a permis d'appréhender la complexité sémantique du domaine et de dégager les entités significatives qui opèrent au sein du domaine. Du fait, nous avons identifié la personne comme étant l'entité qui joue le rôle principal. Cette entité possède la prédisposition à entreprendre des activités. Elle est responsable des décisions de planification des activités et des déplacements. Elle est aussi responsable de la négociation des transactions temps contre espace qui détermine l'éventail des activités faisables en respect au budget temporel, aux services de transport disponibles et aux intérêts des autres

membres du ménage. Le rôle joué par l'entité dans ce contexte transactionnel la dote d'une mémoire structurée autour des événements qui constitue sa trajectoire spatio-temporelle. Accéder au contenu de cette mémoire est la voie royale pour analyser les patrons d'activités. Ainsi, les activités et les déplacements réalisés font partie intégrante de l'identité de la personne.

- (2) Cette appréhension "ontologique" des entités qui peuplent le domaine a soulevé le problème du choix de la méthodologie de représentation des entités. L'intention était de s'assurer que la représentation préserve la complexité structurelle des entités. Notre choix s'est arrêté sur le paradigme orienté-objet qui opérationnalise la métaphore de l'objet et offre un cadre de développement d'application intégré allant de la conception jusqu'au déploiement et ce, avec des pertes sémantiques minimales.
- (3) À l'aide du formalisme UML™ (Unified Modeling Language), nous avons conçu un modèle de données spatio-temporel. Ce modèle reproduit les considérations sémantiques de la première étape. Ce modèle a été porté aisément dans le CaseTool de Smallworld GIS™ et transformé en une base de données.
- (4) La table des données de l'enquête O-D qui sert de banc d'essai a été fragmentée en autant de tables que d'objets dans le modèle de données. Chaque enregistrement de ces tables a été considéré une instance de l'objet



qui lui correspond dans le modèle. Se servant de cette équation, nous avons peuplé la base de données hébergée par Smallworld GIS™.

- (5) Après avoir effectué les ajustements nécessaires de l'interface de Smallworld GIS™, nous avons obtenu le prototype d'une base de données qui reproduit le modèle de données et par conséquent la sémantique du domaine de comportement de transport basé sur l'activité.
- (6) Le prototype encapsule la dimension temporelle du domaine mais ne possède pas d'outils permettant de la révéler. À cette fin, nous avons ajouté des attributs temporels aux objets. Par la suite, nous avons implanté les prédicats temporels d'Allen (1984) sous forme de méthodes héritées par les instances de collections d'objets et de collections d'objets de sélection. L'ensemble des méthodes constituent une interface de requête temporelle qui permet d'interroger les objets comme les collections d'activités et les collections de déplacements comme objets indépendants ou comme collections appartenant à l'objet personne.
- (7) La trajectoire spatio-temporelle constitue l'unité de base du domaine de comportement du transport basé sur l'activité. L'accès à cette unité, à ses composantes atomiques et à leur topologie est nécessaire pour toute entreprise d'analyse et de modélisation. À cette fin, nous lui avons accordé une attention particulière en la modélisant mathématiquement sous forme d'ensemble

temporal totalement ordonné. Par la suite, nous avons déterminé le repérage topologique des événements qu'il soit positionnel indexé ou relatif. Le repérage a été implanté dans des méthodes attachées aux activités, aux déplacements et à la trajectoire elle-même.

- (8) L'interface du prototype est textuelle. La soumission de requêtes exige à la fois une connaissance du langage Magik de Smallworld et une connaissance de la relativement large librairie de méthodes que nous avons développées. Pour combler cette lacune, nous avons conçu et implanté une interface expérimentale basée sur Visual Basic™ qui, en faisant appel aux méthodes développées, automatise la formulation des requêtes et l'affichage des résultats sous forme tabulaire ou sous forme graphique statique et animée. Suite à ce développement, l'utilisateur est en mesure de soumettre facilement des requêtes et d'obtenir des données spatio-temporelles.

Cette démarche nous a permis de confirmer l'ensemble de nos suppositions. Ainsi, la géographie temporelle nous a aidé à concevoir le domaine du comportement de transport basé sur l'activité comme un contexte transactionnel où la personne joue le rôle principal dans l'échange du temps contre l'espace. Les transactions enchâssées dans les trajectoires spatio-temporelles tracent l'historique des activités et fournissent les informations de base à l'analyse du comportement.

L'articulation entre la personne, les activités, les lieux des activités, les programmes des activités, les déplacements, les itinéraires, le réseau routier et la trajectoire spatio-temporelle crée une structure spatio-temporelle complexe et sémantiquement riche. L'approche orientée-objet permet de reproduire cette structure dans un modèle de données représentatif des liens, des hiérarchies, des propriétés et des comportements des entités.

Les protocoles standards de développement de bases de données temporelles ne peuvent pas répondre aux besoins du domaine du comportement de transport basé sur l'activité. La trajectoire spatio-temporelle est une structure spéciale qui doit être soutenue par une modélisation adéquate et un outil de requête approprié.

La stratégie de développement par prototypage a donné les résultats escomptés. Nous avons obtenu un prototype fonctionnel qui réalise les objectifs de la recherche.

Le développement conceptuel et géo-informatique de cette thèse constitue une solide rampe de lancement à de nombreuses recherches. Nous pouvons les classer dans cinq catégories :

(1) Perspective de recherche touchant la soumission des requêtes :

Pour l'instant, le requêteur standard de Smallworld GIS™ et le requêteur temporel opèrent isolément. Il serait profitable de les intégrer dans un seul moteur de requête qui gère simultanément les requêtes spatiales et attributaires standard et les requêtes temporelles et positionnelles. Cette

intégration nécessite la ré-ingénierie du moteur standard afin qu'il soit en mesure de prendre en charge l'algèbre relationnelle et les messages des objets. Dans notre recherche, nous avons utilisé une solution d'intégration simple qui consiste en la priorisation de la requête de sélection suivie par un envoi de messages à chaque élément de la collection repérée sans en cela se soucier des problèmes d'optimisation. Pour des requêtes plus complexes exigeant des stratégies à plusieurs niveaux, une optimisation boiteuse aura des impacts négatifs sur la performance du moteur de requête.

(2) Perspective de recherche touchant la modélisation de la trajectoire spatio-temporelle :

La modélisation mathématique que nous avons proposée pour la trajectoire temporelle se base sur des ensembles totalement ordonnés et des intervalles de temps fermés. D'autre part, elle exclut les cas dégénérés comme celui de deux événements de même type qui se suivent. Nous pensons qu'une extension de la modélisation pour inclure les cas problèmes et les intervalles temporels ouverts permettrait de rendre compte plus fidèlement de la réalité complexe de la trajectoire spatio-temporelle. L'enrichissement du modèle de la trajectoire doit être soutenu par un enrichissement de la librairie des méthodes de requêtes positionnelles.

(3) Perspective de recherche touchant le requêteur de la trajectoire spatio-temporel :

Le requêteur temporel positionnel peut soumettre des requêtes à des trajectoires individuelles. Cependant, il lui manque les opérations sur les ensembles. Ces opérations permettent la comparaison entre les trajectoires et dégagent les similitudes et les différences. Si l'on considère que les éléments des trajectoires sont des intervalles temporels, le défi est relativement passionnant. Le relever, par contre, sera à la base d'un outil de simulation versatile.

(4) Perspective de recherche touchant l'interface :

L'interface graphique actuelle est expérimentale. L'approche sélectionne et clique est standard. Elle peut être l'objet de deux types d'investigations :

- a. Une recherche ergonomique sur l'interaction personne-machine dans le cadre d'une base de données spatio-temporelles. L'objectif serait de concevoir un modèle d'interface possédant des spécifications visuelles qui aide l'utilisateur dans la définition de ses besoins et la délimitation de son espace de solution qui correspondent à ses tâches et à son profil. Cette interface doit exploiter la nature dynamique du prototype et de son domaine d'application. De cette manière, il serait possible de concevoir une interface différente de celle des bases de données statiques.

- b. Le développement d'un langage de scripting dans le but d'offrir un outil de création d'animation cartographique. Cet outil devrait prendre en charge tous les éléments de création de séquences de scènes comme la création du scénario, la soumission des requêtes, la récupération des résultats, la création des scènes, le renforcement de l'effet visuel (stimulation de la perception) et le choix de l'ordre et la durée d'exposition des scènes.

(5) Perspective de recherche touchant l'objet personne :

L'objectif est de transformer l'objet personne en un objet spatial intelligent. Ceci peut être réalisé en enrichissant son comportement (méthodes) par un modèle cognitif de prise de décision et de planification d'activités qui prend en compte les contraintes spatio-temporelles, ménagères, institutionnelles et celles du service de transport. Son comportement simulé comparé avec le comportement d'une personne réelle aiderait à comprendre les attitudes, les processus cognitifs de prise de décision et de résolution de problèmes et par conséquent la manière de l'évolution de l'occupation de l'espace urbain et les causes de l'émergence de nouvelles structures urbaines.

Finalement, la contribution de cette thèse peut être portée à d'autres domaines comme la biographie des personnes, la géographie de la santé, l'architecture, l'utilisation du sol, le cadastre, la foresterie, l'aménagement urbain ou l'archéologie des artefacts et des idées.

## Références

Allen, J. F. 1984. Towards a general theory of action and time. *Artificial Intelligence* 23:123-154

## **Chapitre I : Figures**



Figure 1. System object diagram

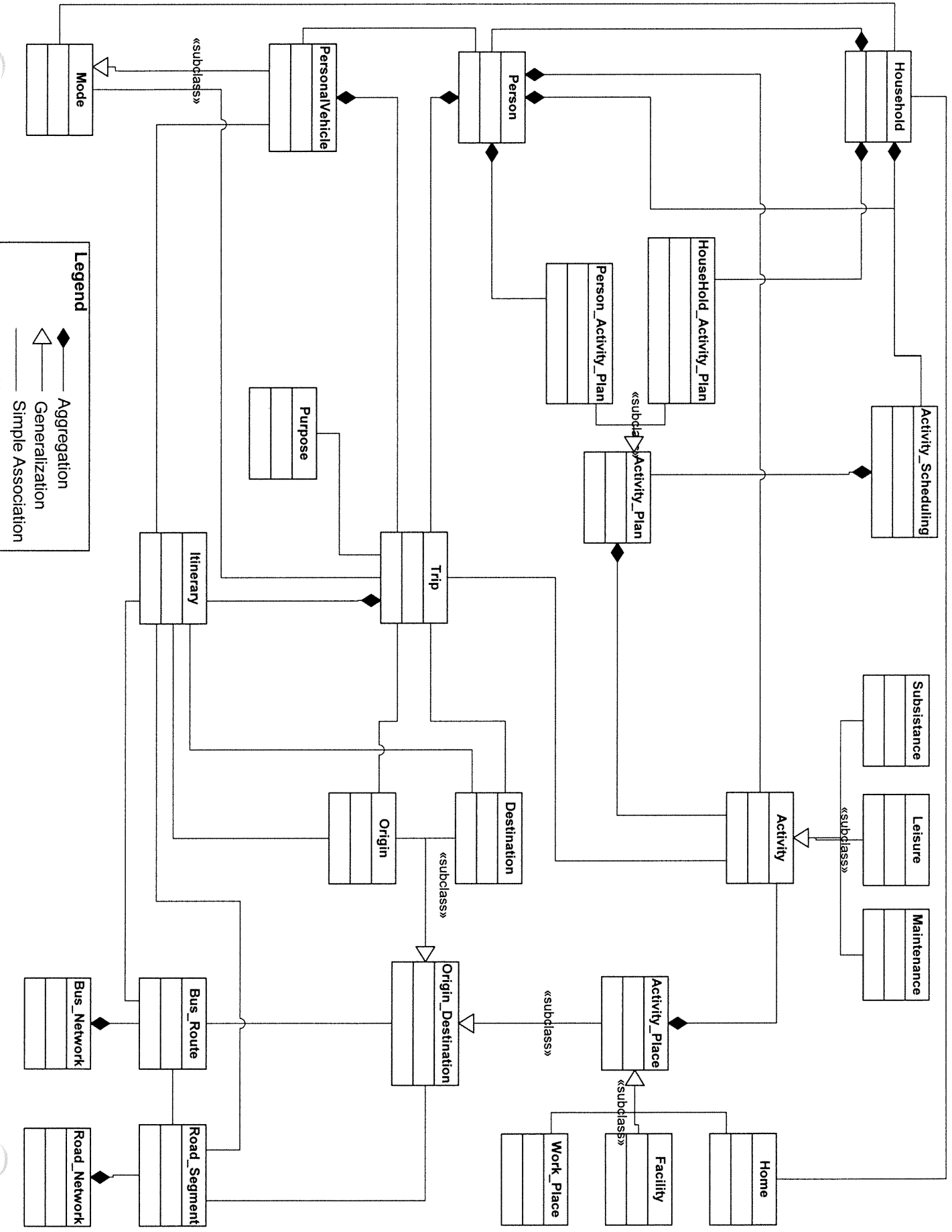

Figure 2. Collaboration diagram with samples of interactions between Person, Trip and Activity objects

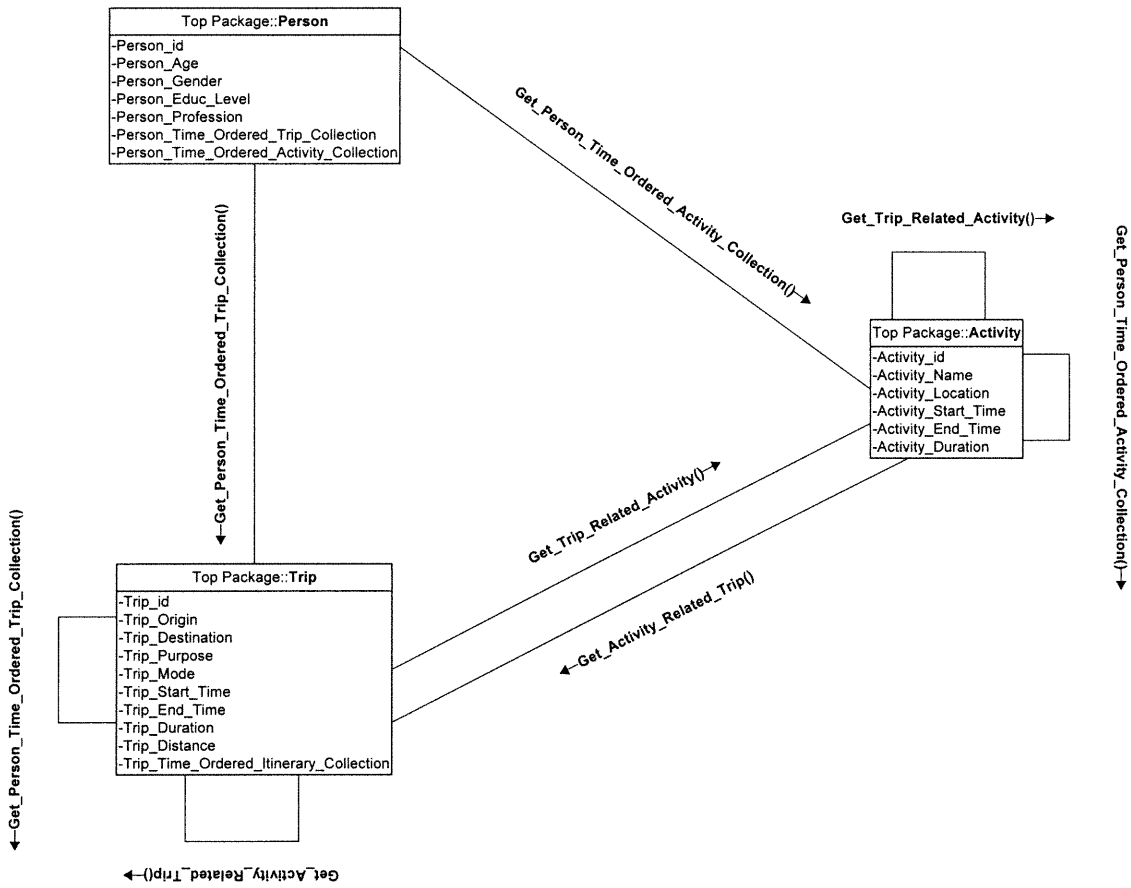

Figure 3. Illustration of the database prototype behavior

The figure illustrates the database prototype behavior through eight numbered screenshots:

- 1:** Household information form. Fields include Household No (1071.00000000), Number of Persons (4.0000000000), Number of Vehicles (2.0000000000), City (SF), State (N), and Postal Code (G1W1S5).
- 2:** Household Members table. Columns: ID/Person, Household No, Sex. Data rows: (107101.00..., 1071.00000000, F), (107102.00..., 1071.00000000, M), (107103.00..., 1071.00000000, M), (107104.00..., 1071.00000000, M).
- 3:** Person information form. Fields include Person No (1.0000000000), Household No (1071.00000000), Age (33.0000000000), Sex (F), Occupation (T), Profession (M), Work at Home (C), Employment Regime (SF), City of Residence (G1W1S5), Postal Code of Residence (SF), City of Work (G1W2A8), Postal Code of Work (G1W2A8), From Household (1071.00000000), Time Ordered Trip Collection (4), and Time Ordered Activities Collection (4).
- 4:** Trip Start Time table. Columns: ID/Date, Postal Code Origin, Postal Code Destination, Trip Start Time. Data rows: (10710106..., G1W1S5, G1V2A8, 30/12/99 18:00:00), (10710110..., G1V2A8, G1W1S5, 30/12/99 17:00:00), (10710115..., G1W1S5, G1V2M2, 30/12/99 18:00:00), (10710120..., G1V2M2, G1W1S5, 30/12/99 22:00:00).
- 5:** Activities table. Columns: Activity Nbr., Activity, Household No. Data rows: (11, T, 1071.00000000), (12, D, 1071.00000000), (13, E, 1071.00000000), (14, D, 1071.00000000).
- 6:** Trip Related Person form. Fields include ID/Date (10710106.0000), Postal Code Origin (G1W1S5), Postal Code Destination (G1V2A8), Trip Start Time (30/12/99 08:00:00), Trip Mode (C), Trip Related Person (1), and Trip Road Segments Collection (43).
- 7:** Activity Nbr form. Fields include Activity Nbr (11), Activity (T), Household No (1071.00000000), Activity Related Trip (10710106.0000), Activity Place Location (G1V2A8), and Persons (1).
- 8:** Activity Place Postal Code form. Fields include Activity Place Postal Code (G1V2A8), Longitude (71.2847365333), Latitude (46.758550325), location (54818), Street n/Vicinity (158), and Petnamed Activities Collection (158).
- 9:** Map view showing a street network with a scale of 1:33367.

## **Chapitre II : Tableaux et figures**

Table 1. Temporal predicates

Representation	Predicates
$[p_1, p_2]$ equals $[q_1, q_2]$	$p_1 = q_1$ AND $p_2 = q_2$
$[p_1, p_2]$ before $[q_1, q_2]$	$p_2 + 1 < q_1$
$[p_1, p_2]$ meets $[q_1, q_2]$	$p_2 = q_1$
$[p_1, p_2]$ overlaps $[q_1, q_2]$	$p_1 < q_1$ AND $p_2 < q_2$ AND $q_1 < p_2$
$[p_1, p_2]$ starts $[q_1, q_2]$	$p_1 = q_1$ AND $p_2 < q_2$
$[p_1, p_2]$ ends $[q_1, q_2]$	$q_1 < p_1$ AND $p_2 = q_2$
$[p_1, p_2]$ during $[q_1, q_2]$	$q_1 < p_1$ AND $p_2 < q_2$

Table 2. Implemented position methods

Operator	Method signature	Proprietary Object	Result
~	Activity_list()	Person	Time ordered Activity collection
~	Trip_list()	Person	Time ordered trip collection
$\alpha$	First ()	Activity	First activity
$\omega$	Last()	Activity	Last activity
$\alpha$	First()	Trip	First trip
$\omega$	Last ()	Trip	Last trip
$\eta$	Next(target)	Trip	Next trip at target
$\eta$	Next(target)	Activity	Next activity at target
$\pi$	Previous (target)	Trip	Previous trip at target
$\pi$	Previous (target)	Activity	Previous activity at target
$\chi$	Activity(position)	Person	Position specified trip
$\chi$	Trip(position)	Person	Position specified activity
$\Sigma$	Activities_count()	Person	Total of activities
$\Sigma$	Trips_count()	Person	Total of trips

Table 3. Implemented time path position methods (a) Event methods

Operator	Method signature	Proprietary Object	Result
~	Time_path()	Person	Time Path = Time ordered trip and activity chain
$\alpha$	First_event()	Person	First event on time path
$\omega$	Last_event()	Person	Last event on time path
$\chi$	Event(position)	Person	Event at position
$\iota$	Event_type(position)	Person	Event type at position
$\gamma$	Event_name(position)	Person	Event name at position
$\sigma$	Event_before(position)	Person	Event before
$\tau$	Event_after(position)	Person	Event after
$\sigma$	Activity_before_event(position)	Person	Activity before event
$\tau$	Activity_after_event(position)	Person	Activity after event
$\sigma$	Trip_before_event(position)	Person	Trip before event
$\tau$	Trip_after_event(position)	Person	Trip after event
$\Sigma$	Event_count()	Person	Total of events

Table 3. Implemented time path position methods (b) Activity methods

Operator	Method signature	Proprietary Object	Result
$\alpha$	First_activity()	Person	First activity on time path
$\omega$	Last_activity()	Person	Last activity on time path
$\eta$	Next_activity(position,target)	Person	Next activity at target
$\pi$	Previous_activity(position,target)	Person	Previous activity at target
$\pi$	Activity_previous_trip(position, target)	Person	Previous trip at target from activity at position
$\eta$	Activity_next_trip(position, target)	Person	Next trip at target from activity at position
$\Sigma$	Activity_count()	Person	Total of activities
$\eta$	Next_activity(target)	Trip	Next activity at target from trip
$\pi$	Previous_activity(target)	Trip	Previous activity at target from trip



Table 3. Implemented time path position methods (c) Trip methods

Operator	Method signature	Proprietary Object	Result
$\alpha$	First_trip()	Person	First trip on time path
$\omega$	Last_trip()	Person	Last trip on time path
$\eta$	Next_trip(position,target)	Person	Next trip at target
$\pi$	Previous_trip(position,target)	Person	Previous activity at target
$\pi$	Trip_previous_activity(position, target)	Person	Previous activity at target from trip at position
$\eta$	Trip_next_activity(position, target)	Person	Next activity at target from trip at position
$\Sigma$	Trip_count()	Person	Total of trips
$\eta$	Next_trip(target)	Activity	Next trip at target from activity
$\pi$	Previous_trip(target)	Activity	Previous trip at target from activity

Table 4. Set of utility methods (a) Class 1

Method	Proprietary Object	Result class
trip_with_mode(str)	Person	1
activity_with_mode(str)	Person	1
trip_with_purpose(str)	Person	1
activity_with_purpose(str)	Person	1
activity_after_activity_purpose(str)	Person	1

Table 4. Set of utility methods (b) Class 2

Method	Proprietary Object	Result class
activity_before_activity_purpose(str)	Person	2
activity_after_activity_mode(str)	Person	2
activity_before_activity_mode(str)	Person	2
activity_after_trip_purpose(str)	Person	2
activity_before_trip_purpose(str)	Person	2
activity_after_trip_mode(str)	Person	2
activity_before_trip_mode(str)	Person	2
trip_after_trip_purpose(str)	Person	2
trip_before_trip_purpose(str)	Person	2
trip_after_trip_mode(str)	Person	2
trip_after_activity_purpose(str)	Person	2
trip_before_activity_purpose(str)	Person	2
trip_after_activity_mode(str)	Person	2

Table 4. Set of utility methods (c) Class 3

Method	Proprietary Object	Result class
event_after_activity_mode(str)	Person	3
event_before_activity_mode(str)	Person	3
event_after_activity_purpose(str)	Person	3
event_before_activity_purpose(str)	Person	3
event_after_trip_mode(str)	Person	3
event_before_trip_mode(str)	Person	3
event_after_trip_purpose(str)	Person	3
event_before_trip_purpose(str)	Person	3

Figure 1. Database collaboration diagram

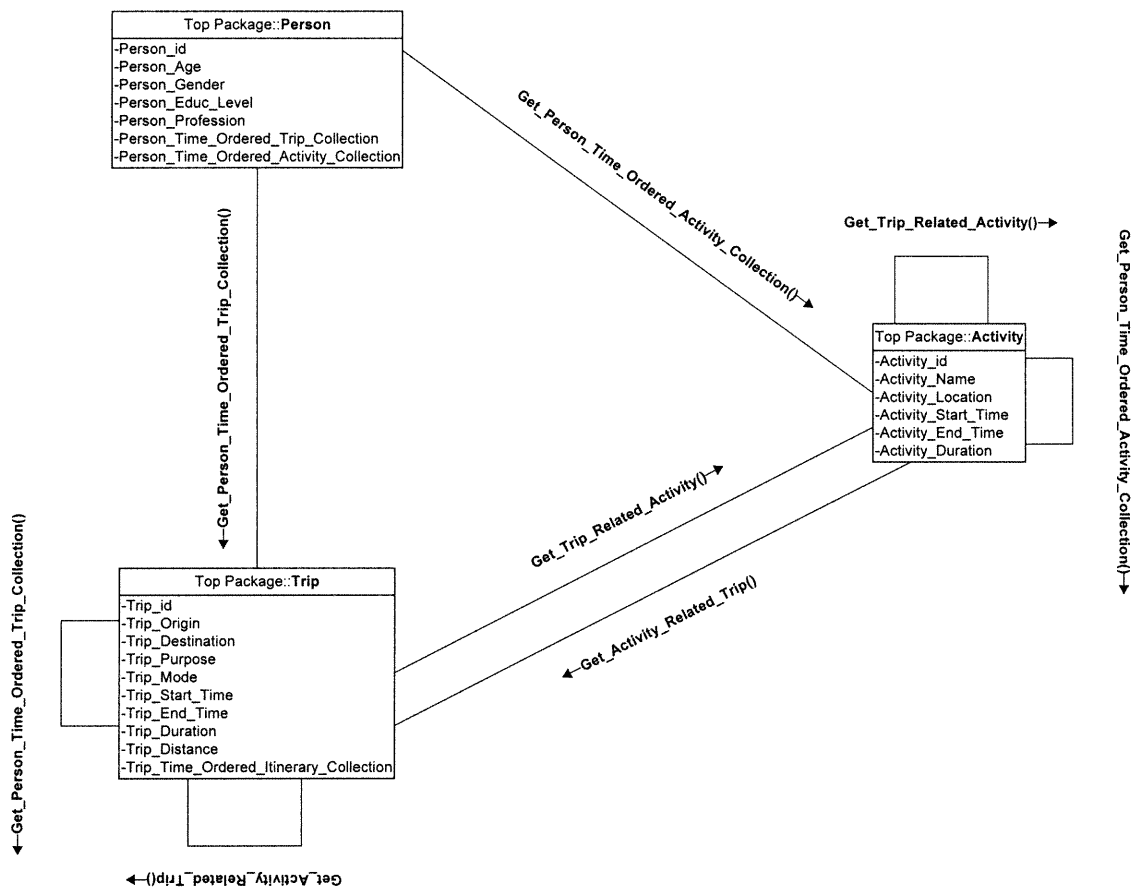

Figure 2. Activity event chain



Figure 3. Move (Trip) event chain



Figure 4. Time path event chain



Figure 5. Temporal relationships

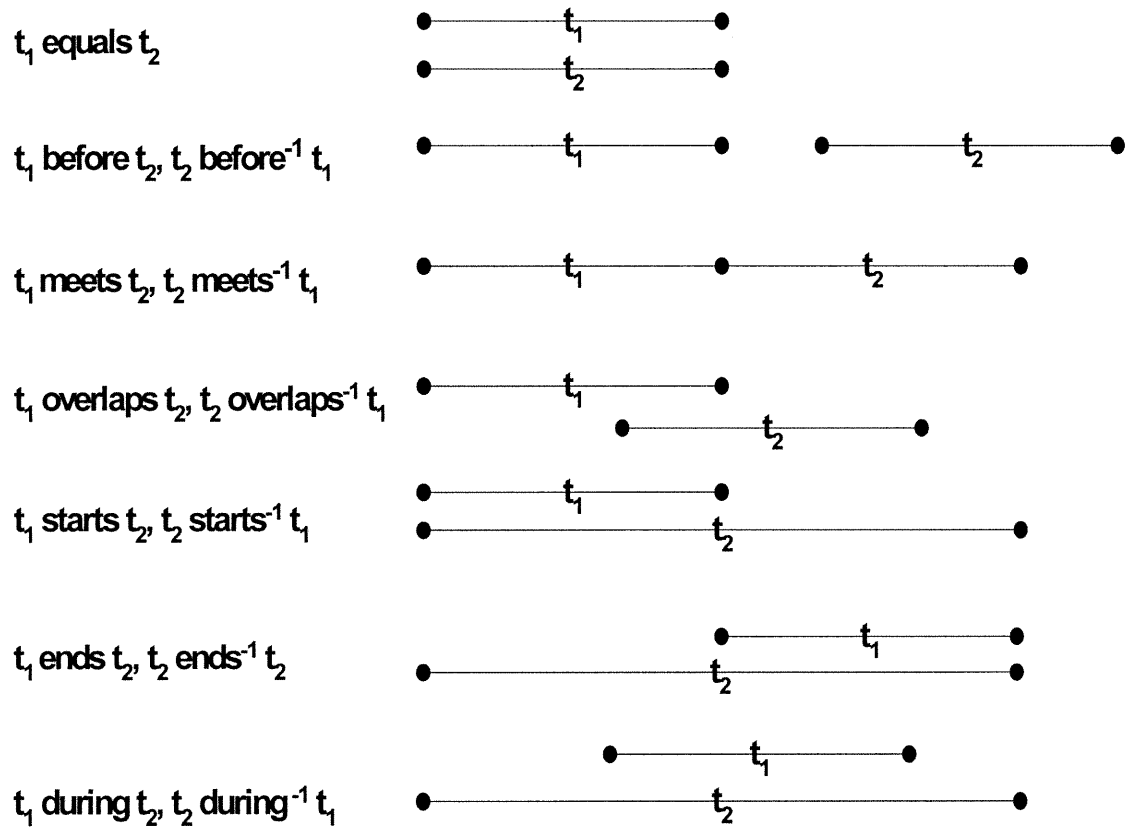

Figure 6. Examples of position functions on an activity event chain.

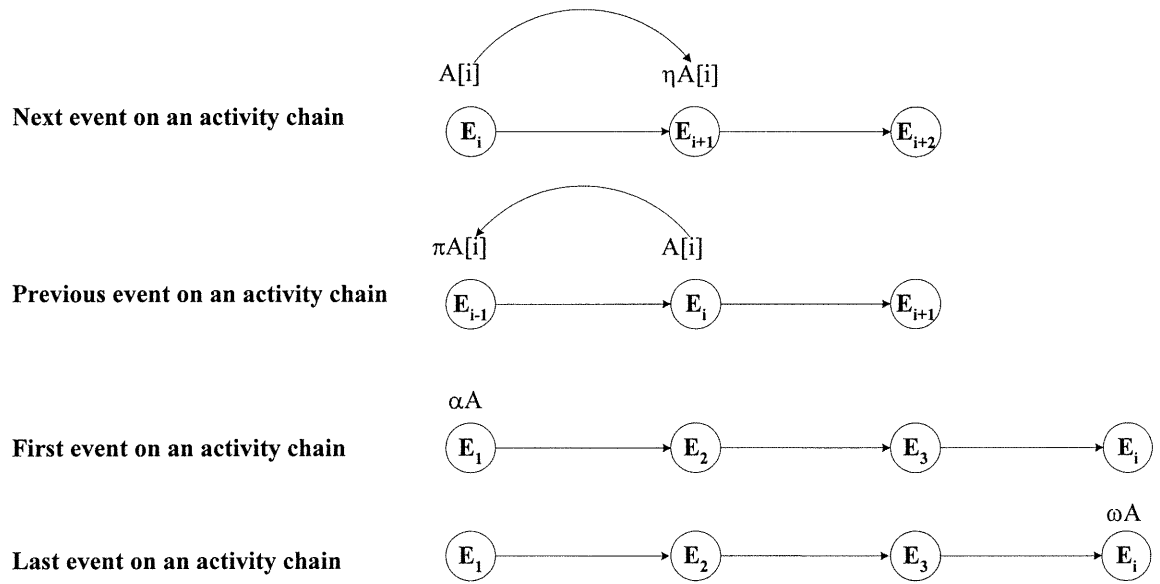



Figure 7. Examples of time path event position functions

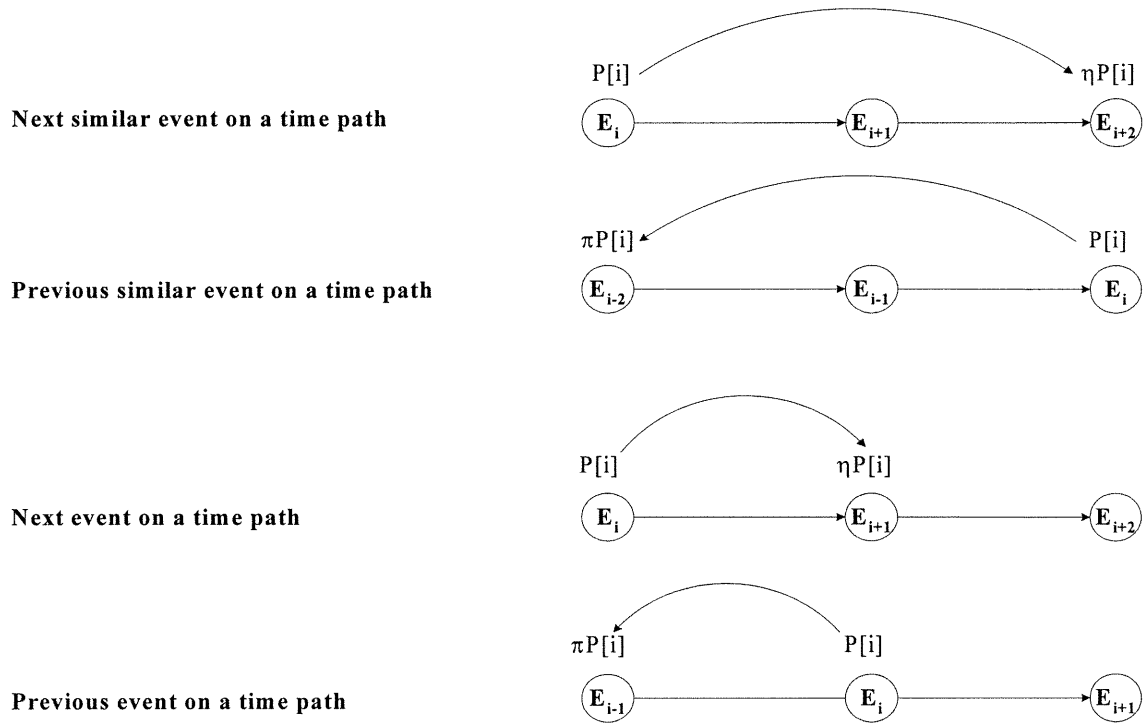

Figure 8. Allen's meets predicate fired as a method by the activity object

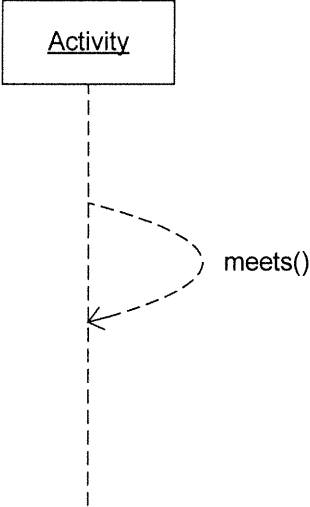

Figure 9. Allen's overlaps predicate fired from the person object level

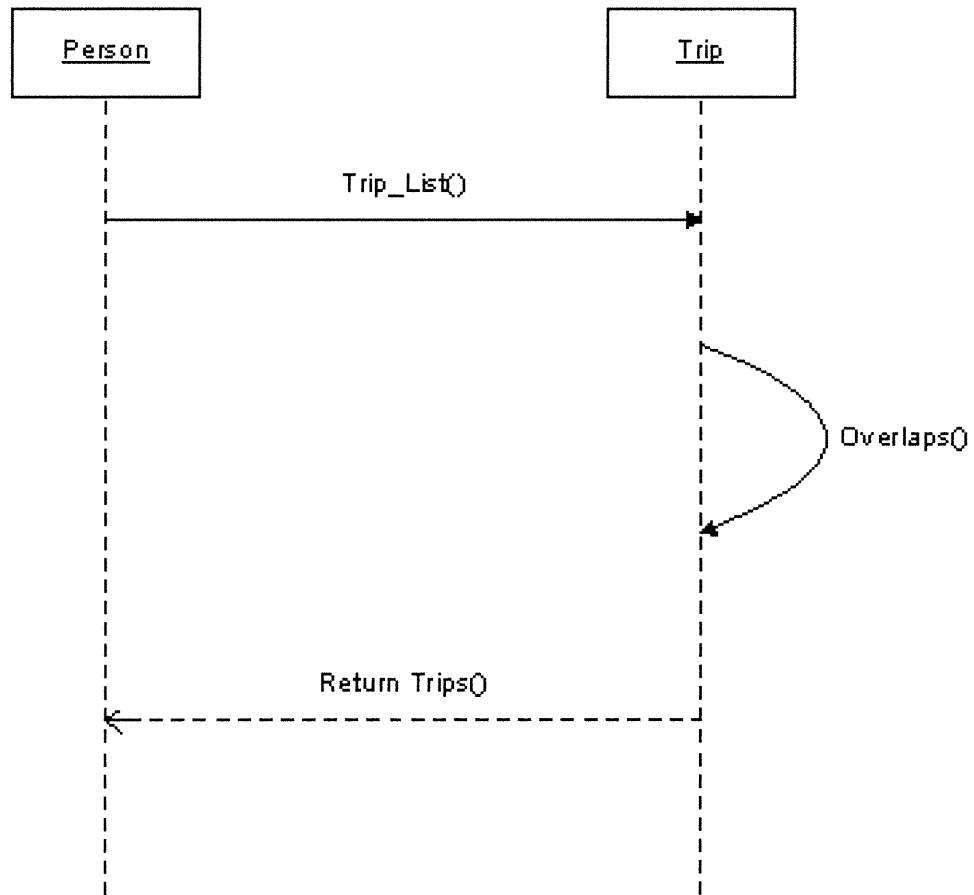

Figure 10. Trip previous activity query sequence diagram

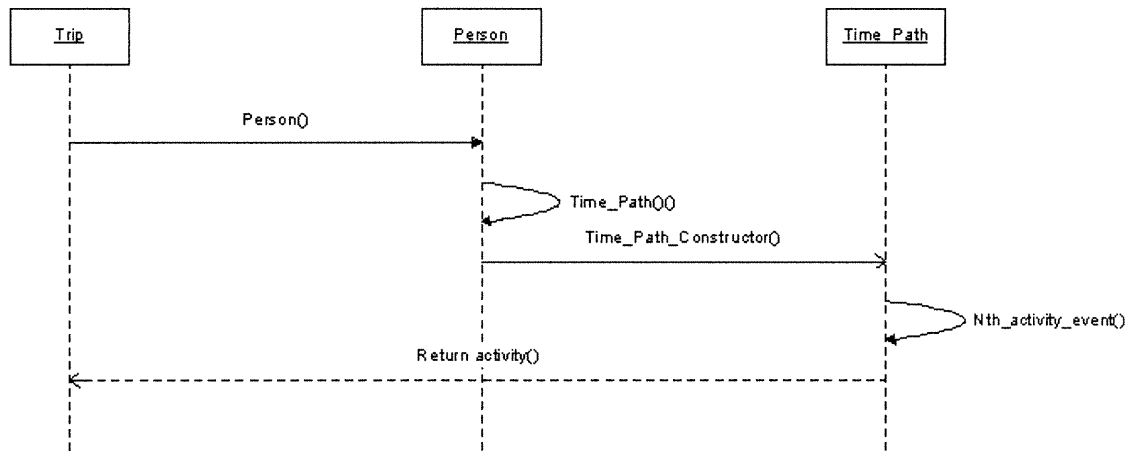

Figure 11. Person activity next trip sequence diagram

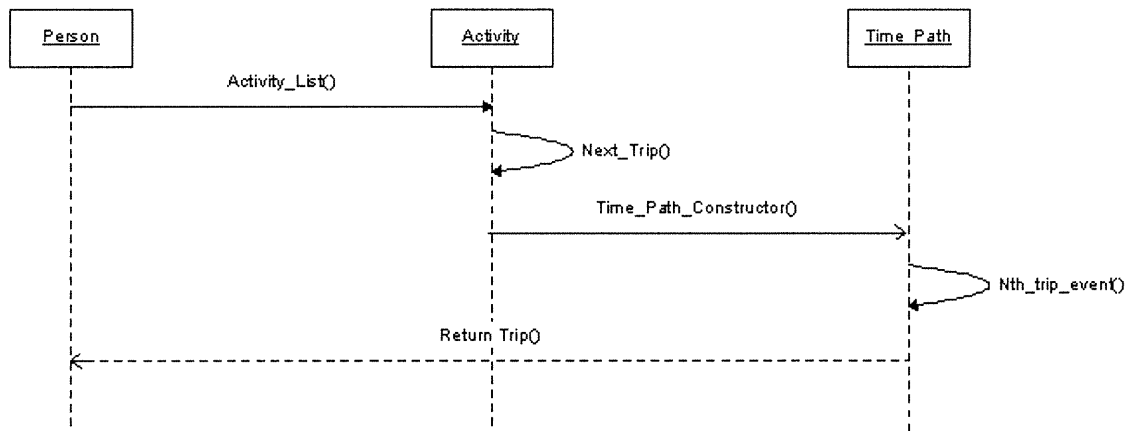

Figure 12. Person activity before trip mode sequence diagram

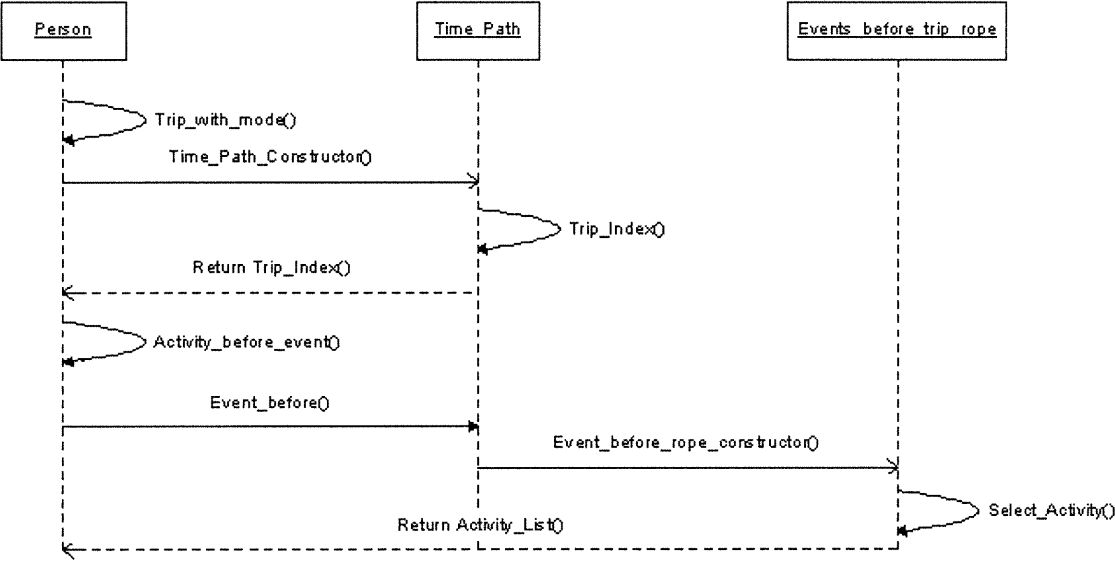
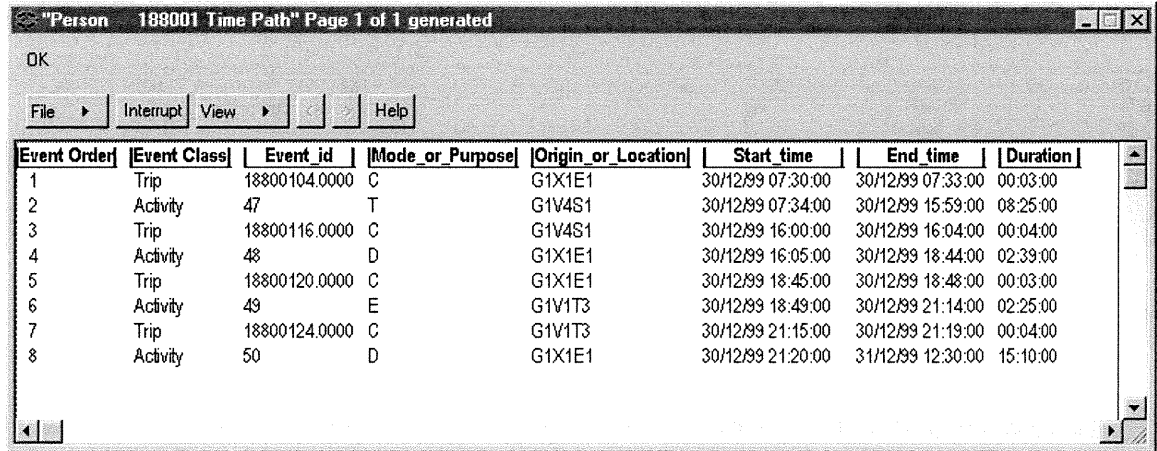

Figure 13. A person time path



The screenshot shows a software window titled "Person 188001 Time Path" Page 1 of 1 generated. The window contains a menu bar with "File", "Interrupt", "View", and "Help". Below the menu bar is a table with 8 rows of event data. The table has columns for Event Order, Event Class, Event\_id, Mode\_or\_Purpose, Origin\_or\_Location, Start\_time, End\_time, and Duration.

Event Order	Event Class	Event_id	Mode_or_Purpose	Origin_or_Location	Start_time	End_time	Duration
1	Trip	18800104.0000	C	G1X1E1	30/12/99 07:30:00	30/12/99 07:33:00	00:03:00
2	Activity	47	T	G1V4S1	30/12/99 07:34:00	30/12/99 15:59:00	08:25:00
3	Trip	18800116.0000	C	G1V4S1	30/12/99 16:00:00	30/12/99 16:04:00	00:04:00
4	Activity	48	D	G1X1E1	30/12/99 16:05:00	30/12/99 18:44:00	02:39:00
5	Trip	18800120.0000	C	G1X1E1	30/12/99 18:45:00	30/12/99 18:48:00	00:03:00
6	Activity	49	E	G1V1T3	30/12/99 18:49:00	30/12/99 21:14:00	02:25:00
7	Trip	18800124.0000	C	G1V1T3	30/12/99 21:15:00	30/12/99 21:19:00	00:04:00
8	Activity	50	D	G1X1E1	30/12/99 21:20:00	31/12/99 12:30:00	15:10:00

Figure 14. Space depiction of a day behavior

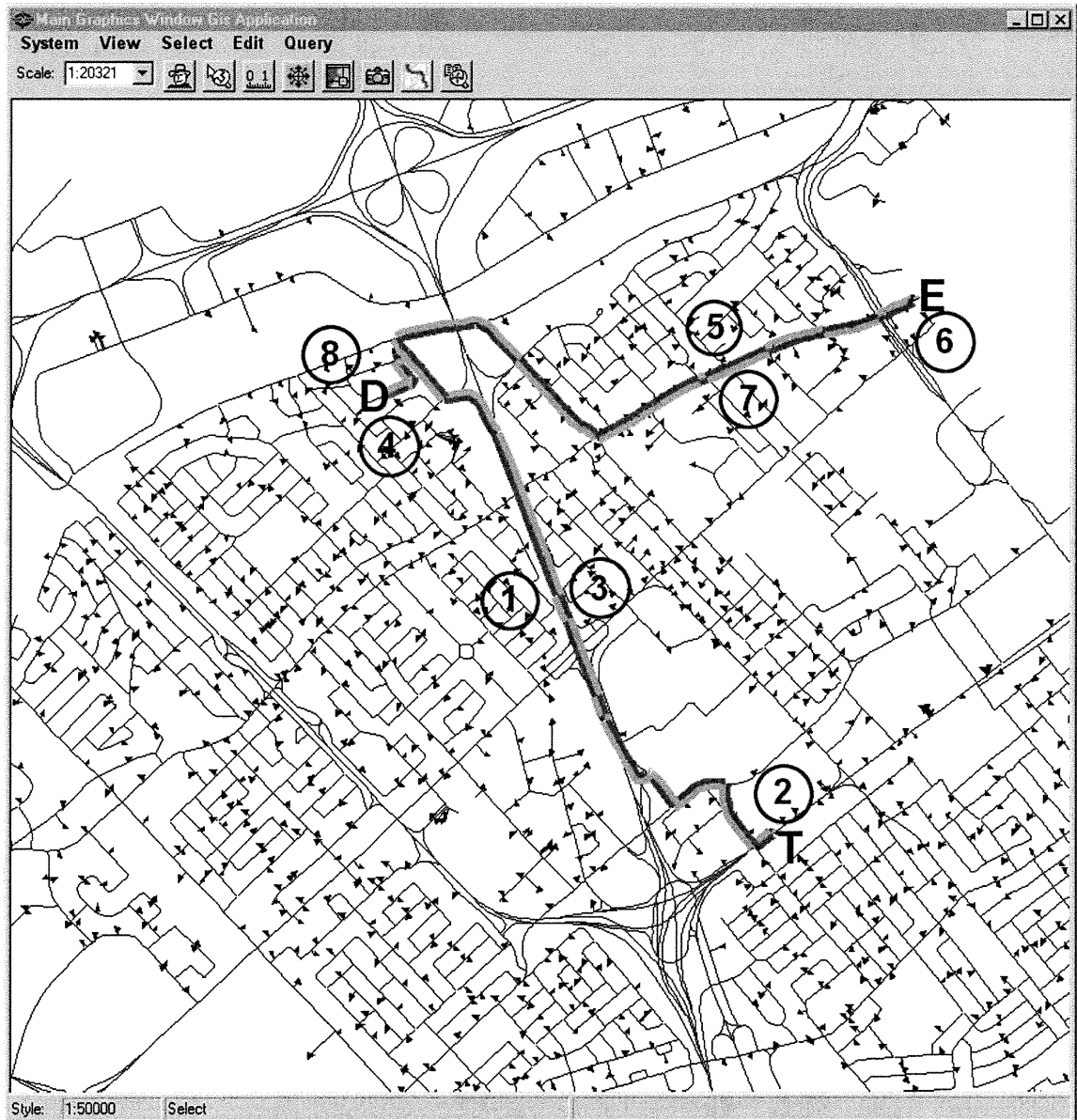



### **Chapitre III : Tableaux et figures**

Table 1. Style allocation matrix.

Purpose \ Mode	Personal Vehicle	Taxi	Bus	Bike	Walking	Activity Place
Work						
Study						
Shopping						
Entertainment						
Home_Still						
Others						

Figure 1. Illustration of the space-time path (courtesy of Chrisman, 1998)

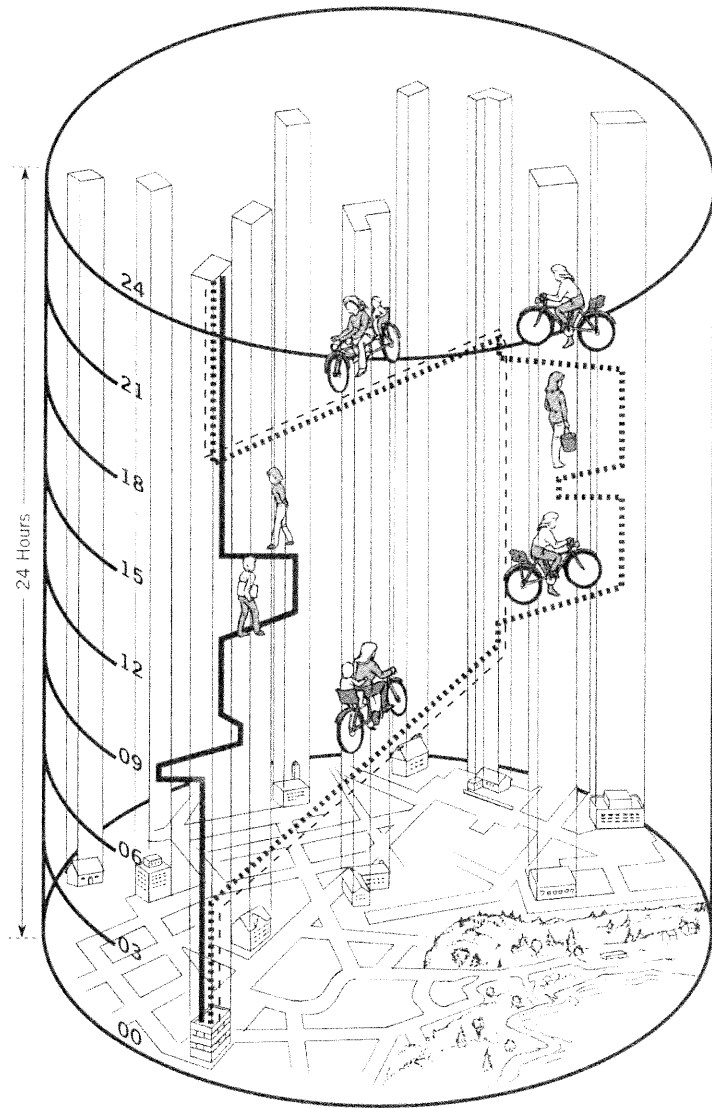

Figure 1 BTB object diagram.

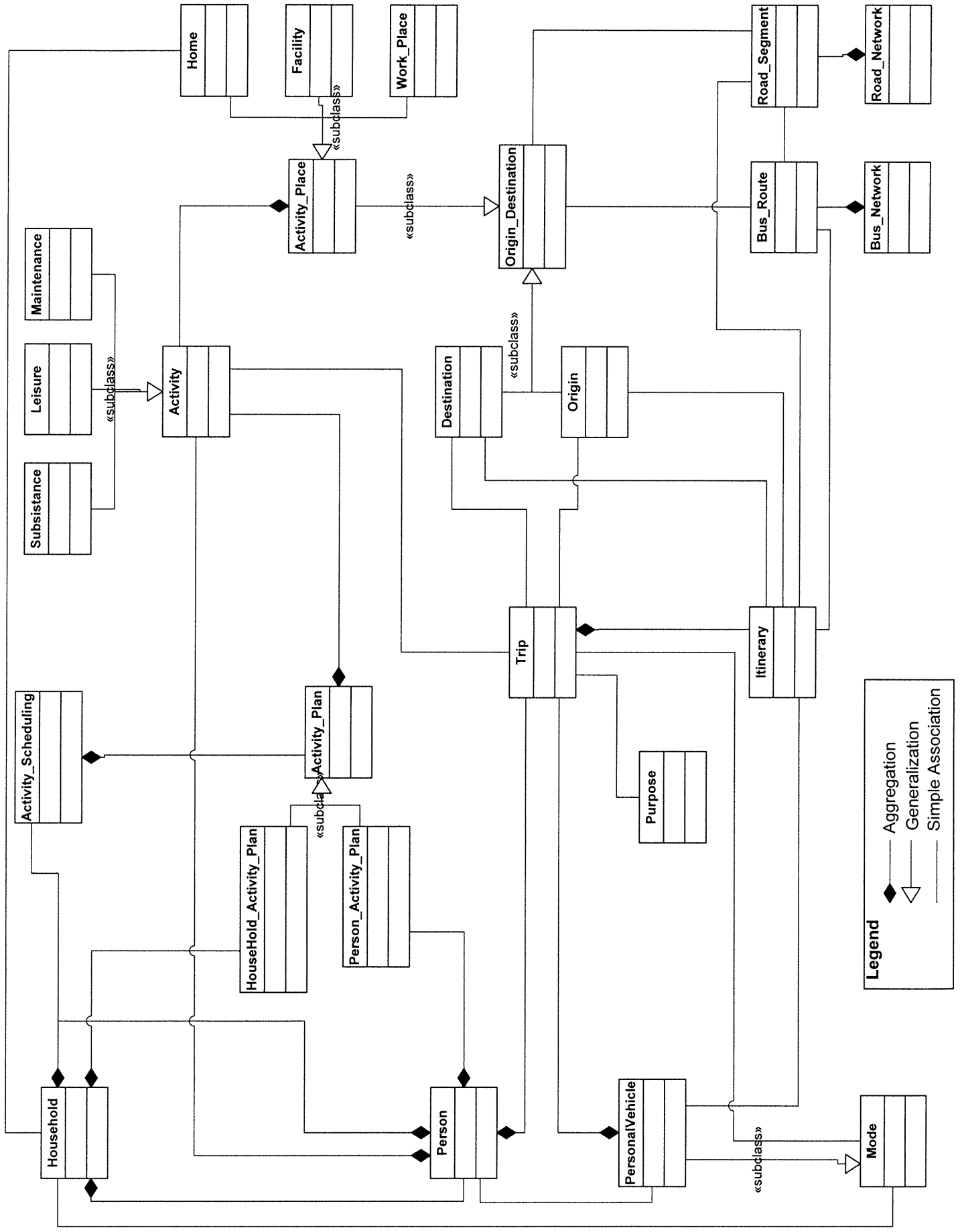
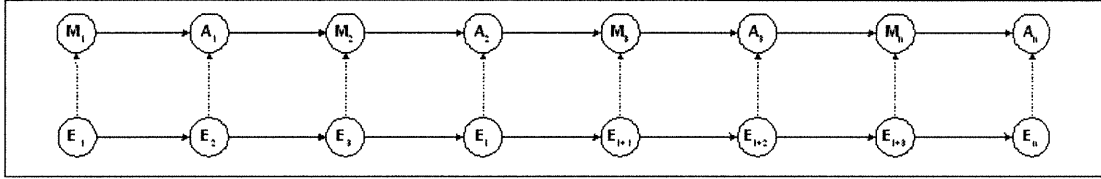
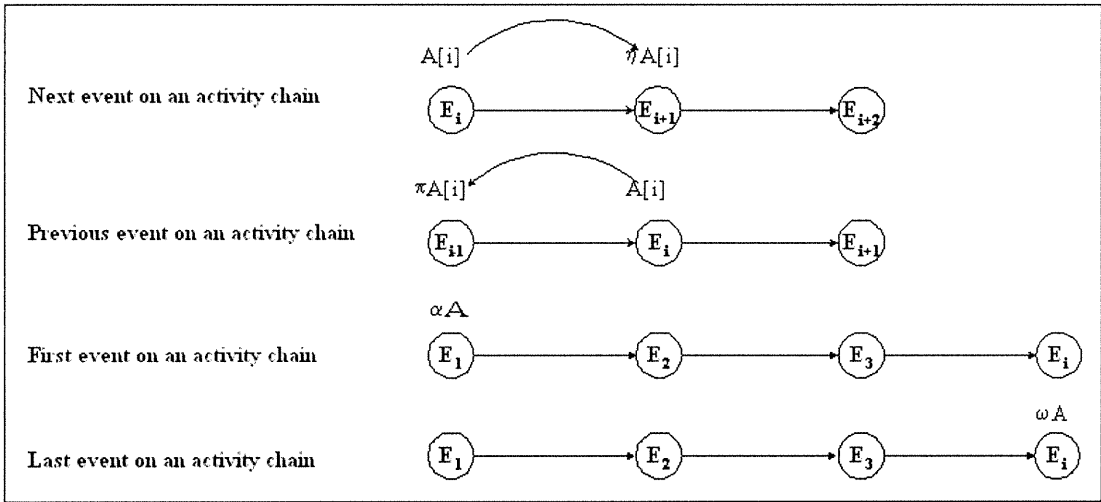

Figure 3. Activity-based events: (a) Activity-Trip chaining (A-Activity, M-Trip), (b) Activity or Trip positioning, (c) Time-path positioning



a)



b)

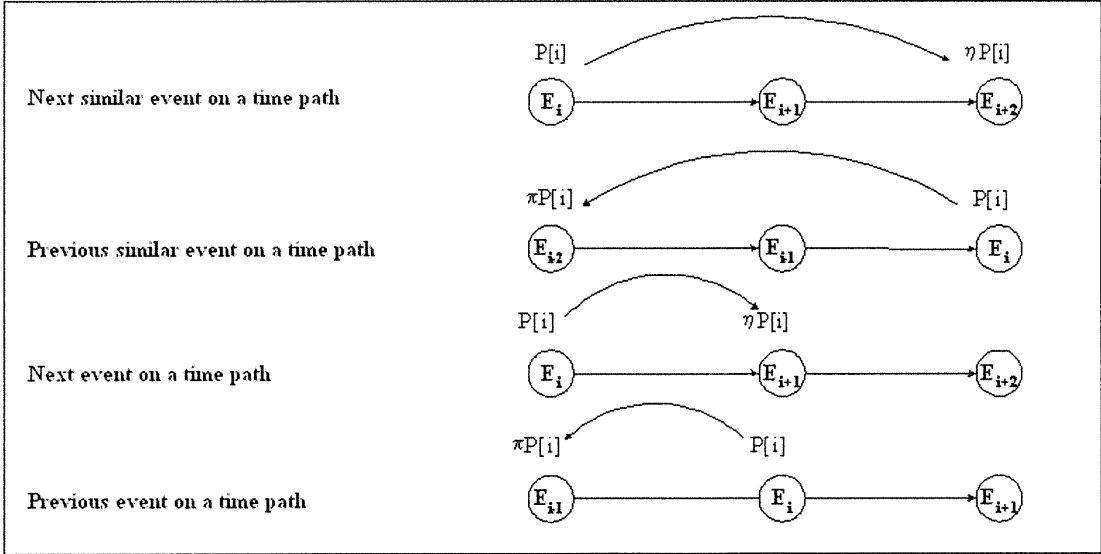

c)

Figure 4. Work (T) activities in the activity place “G1V2L8” during the period between 08:00:00 and 20:00:00

The screenshot shows a software interface for querying work activities. The interface is divided into several sections:

- Household:** A list box containing 1041, 1071, and 1180.
- Person:** An empty text box.
- Activity:** An empty text box.
- Trip:** An empty text box.
- Selection:** A section with a checked "Select Group" checkbox. Below it, a "Select From Activity Where" section contains a query:
 

```
location eq G1V2L8
And
but_deplac.eq.T
And
location.eq.G1V2L8
```

 To the right of the query are buttons for "Add", "And", "Or", "Remove", and "Clear".
- Result Size:** A list box on the right side of the Selection section contains the numbers 11, 33, 136, 149, 290, 566, 695, 752, 782, 784, and 972. Below it, a "Result Size" field shows the value 28.
- Query Section:** Below the Selection section are three tabs: "Person Query", "Activity Query", and "Trip Query". The "Activity Query" tab is active. It contains an "Ordinal Query" section with a dropdown menu set to "Ordinals" and a "Seek" button. Below that is a checked "Allen's Predicates" section with a dropdown menu set to "during(start\_time,end\_time)". It has fields for "Start\_Time" (08:00:00) and "End\_Time" (20:00:00), and buttons for "Seek", "Locate", and "Locate All". A "Result Objects Size" field shows the value 8.
- Results Table:** A table with the following data:
 

Activity_Nbr	Activity	Location	Start Time	End Time	Duration
11	T	G1V2L8	08:04:00	16:59:00	08:55:00
33	T	G1V2L8	09:04:00	16:59:00	07:55:00
136	T	G1V2L8	08:50:00	11:59:00	03:09:00
149	T	G1V2L8	09:18:00	17:29:00	08:11:00
695	T	G1V2L8	08:10:00	16:59:00	08:49:00
782	T	G1V2L8	10:35:00	18:59:00	08:24:00
972	T	G1V2L8	20:32:00	07:59:00	11:27:00
1205	T	G1V2L8	08:08:00	15:59:00	07:51:00
- Quit:** A button located at the bottom right of the interface.

Figure 5. The trip that immediately follows the activity 33

**Household**  
 1041  
 1071  
 1180

**Person**  
 [Empty Field]

**Activity**  
 [Empty Field]

**Trip**  
 [Empty Field]

**Selection**  
 Select Group  
 Select From Activity Where  
 location eq G1V2L8  
 but\_deplac.eq.T  
 And  
 location.eq.G1V2L8

Buttons: Add, And, Or, Remove, Clear

Result Objects Size: 28

---

**Person Query** **Activity Query** **Trip Query**

Ordinal Query

Activity: next\_trip[optarg]  
 33 next\_trip [Empty Field] Seek Itinerary Locate

Allen's Predicates

during(start\_time,end\_time) Start Time End Time Result Objects Size  
 during 08:00:00 20:00:00 Seek Locate Locate All 0

Trip_Nbr	Origin	Destination	Purpose	Mode	Start Time	End Time	Duration
15000110	G1V2L8	G1W2L1	D	C	17:00:00	17:03:00	00:03:00

Quit

Figure 6. Shopping activity (M) performed by female people having an age greater than 65

The screenshot shows a software interface for querying shopping activity. The interface is divided into several sections:

- Household:** A dropdown menu with values 1041, 1071, and 1180.
- Person:** A dropdown menu with values 104101, 104102, and 104103.
- Activity:** A dropdown menu with values 3, 4, and 5.
- Trip:** A dropdown menu with values 10410205, 10410210, and 10410215.
- Selection:** A section with a checked 'Select Group' box. It contains a query builder with 'Select From' set to 'Person' and 'Where' containing the criteria: 'sexe eq F', 'age.gt.65', and 'sexe.eq.F'. There are buttons for 'Add', 'And', 'Or', 'Remove', and 'Clear'.
- Person Query:** A section with a search bar containing 'activity\_having\_purpose{purpose}' and a dropdown menu set to 'M'. A 'Seek' button is next to it. Below are 'Locate Activity' and 'Locate All' buttons.
- Table:** A table with the following columns: Person id, Activity\_Nbr, Activity, Location, Start Time, End Time, and Duration. The table contains 14 rows of data.
- Result Set Size:** A field showing the value 40.
- Quit:** A button at the bottom right.

Person id	Activity_Nbr	Activity	Location	Start Time	End Time	Duration
146201	31	M	G1V2L8	14:04:00	16:59:00	02:55:00
217601	66	M	G1W2V8	00:00:00	16:44:00	00:00:00
394001	177	M	G1V2L8	10:02:00	12:59:00	02:57:00
506601	259	M	G1V2L8	00:00:00	11:59:00	00:00:00
543601	274	M	G1V2L1	13:33:00	15:29:00	01:56:00
575402	282	M	G1V2L8	18:02:00	18:59:00	00:57:00
618501	321	M	G1V2L8	00:00:00	20:44:00	00:00:00
651301	375	M	G1W4S6	08:49:00	09:29:00	00:40:00
849201	513	M	G1V2L8	14:33:00	15:29:00	00:56:00
849201	514	M	G1V2L1	15:32:00	17:29:00	01:57:00
971902	586	M	G1V2L8	00:00:00	12:29:00	00:00:00
1036101	618	M	G1V2L1	10:04:00	13:59:00	03:55:00
1052601	641	M	G1W4N2	12:47:00	13:44:00	00:57:00



Figure 7. Places visited by female people having an age greater than 65

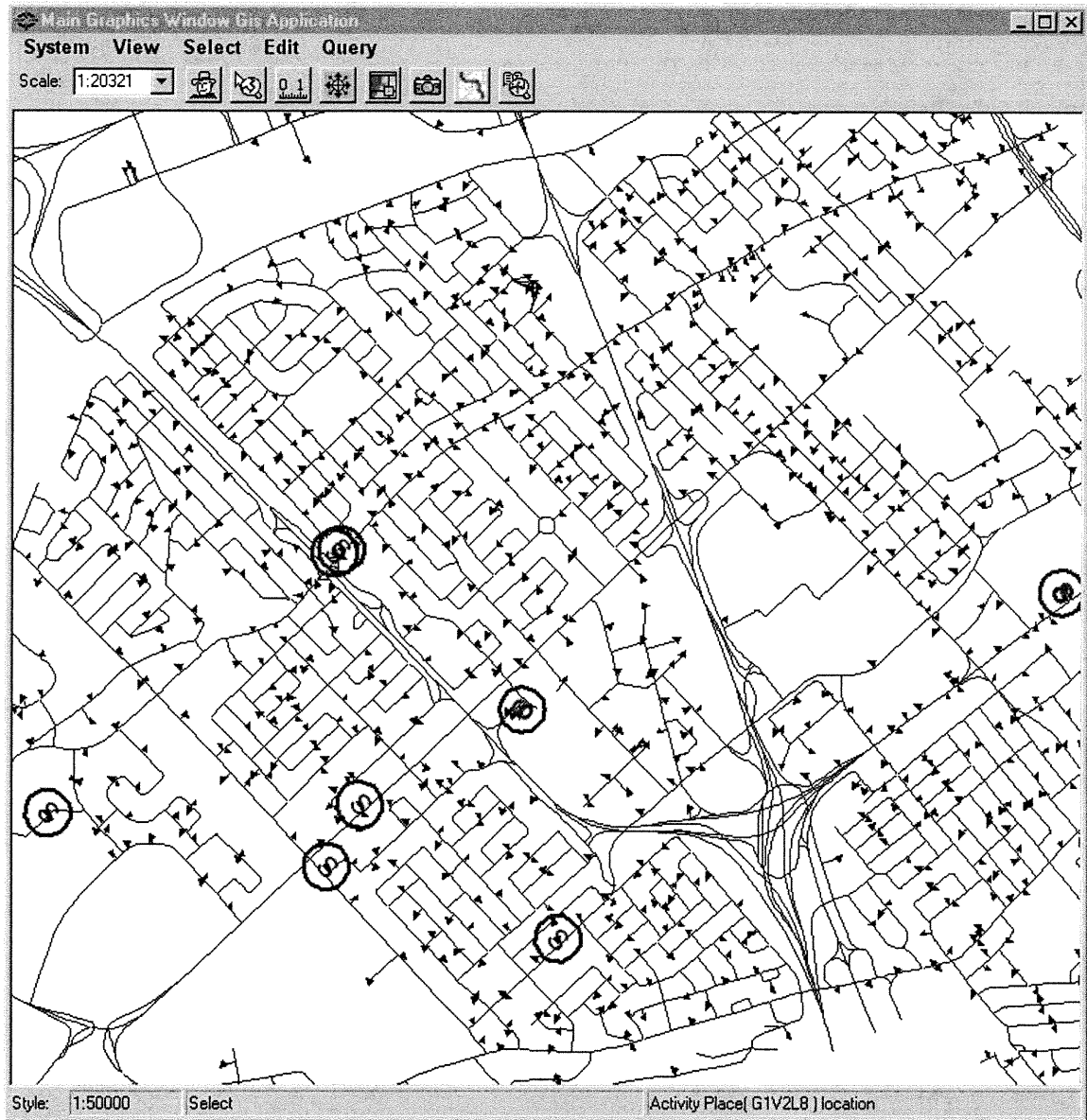

Figure 8. Trips meeting the time stamp = 09:33:00

The screenshot shows a software application window titled "Person". It is divided into several sections for data selection and querying.

- Household:** A list of household IDs: 1041, 1071, 1180.
- Person:** A list of person IDs: 104101, 104102, 104103.
- Activity:** A list of activity IDs: 3, 4, 5.
- Trip:** A list of trip IDs: 10410205, 10410210, 10410215.
- Selection:** A query builder area with a checked "Select Group" option. It shows criteria: "age" > "65" and "sexe.eq.F". Buttons for "Add", "And", "Or", "Remove", and "Clear" are present. A list of IDs (118001 to 543601) and a "Result Size" of 78 are also visible.
- Person Query:** A search section with a dropdown menu showing "person\_trip\_meets(start\_time)", a text input field with "09:33:00", and a "Seek" button. The "Result Set Size" is shown as 2.
- Itinerary:** A table displaying the results of the query.
- Quit:** A button in the bottom right corner.

Trip_Nbr	Origin	Destination	Purpose	Mode	Start Time	End Time	Duration
65130112	G1W4S6	G1X2P8	D	P	09:30:00	09:33:00	00:03:00
272890112	G1V4S2	G1V2L8	M	P	09:30:00	09:33:00	00:03:00

Figure 9. The first trip of the current individual

The screenshot shows a software interface for querying trip data. It includes several dropdown menus for selection: Household (1041, 1071, 1180), Person (104101, 104102, 104103), Activity (3, 4, 5), and Trip (10410205, 10410210, 10410215). A 'Selection' panel allows building a query with 'Select From' and 'Where' clauses, including 'Add', 'And', 'Or', 'Remove', and 'Clear' buttons. Below the selection panel are tabs for 'Person Query', 'Activity Query', and 'Trip Query'. The 'Person Query' section shows a dropdown for 'Person' (104102) and a text field for 'first\_trip'. A 'Seek' button is present. On the right, 'Activity Count' and 'Trip Count' are both 6. At the bottom, a table displays the first trip details:

Trip_Nbr	Origin	Destination	Purpose	Mode	Start Time	End Time	Duration
10410205	G1X3Y2	G1V3W5	T	C	08:45:00	08:50:00	00:05:00

Figure 11. The third trip after the second activity performed by the current individual

**Household**

1041  
1071  
1180

**Person**

104101  
104102  
104103

**Activity**

3  
4  
5

**Trip**

10410205  
10410210  
10410215

**Selection**

Select Group

Select From Person Where

Select field Select Operator

Add  
And  
Or  
Remove  
Clear

Result Size

**Person Query** **Activity Query** **Trip Query**

Person activity\_next\_trip[pos. optarg]

104102 activity\_next\_trip 2 2 Seek

Activity Count 6  
Trip Count 6

Show Diary Itinerary

Trip_Nbr	Origin	Destination	Purpose	Mode	Start Time	End Time	Duration
10410225	G1X3Y2	G1V3W5	T	C	18:30:00	18:35:00	00:05:00

Quit

Figure 12. The third activity performed just before the fourth trip

Person

Household  
 1041  
 1071  
 1180

Person  
 104101  
 104102  
 104103

Activity  
 3  
 4  
 5

Trip  
 10410205  
 10410210  
 10410215

Selection  
 Select Group  
 Select From Person Where  
 Select field Select Operator  
 Add  
 And  
 Or  
 Remove  
 Clear

Result Size

Person Query Activity Query Trip Query

Person  
 104102

trip\_previous\_activity(pos, optarg)  
 trip\_previous\_activity 4 2

Seek

Activity Count 6  
 Trip Count 6

Show Diary Locate Activity Locate All

Activity_Nbr	Activity	Location	Start Time	End Time	Duration
3	T	G1V3W5	08:51:00	11:59:00	03:08:00

Quit

Figure 13. The activities performed by the current individual before 18:00:00

The screenshot shows a software window titled "Person" with several sections:

- Household:** A list with 1041 selected.
- Person:** A list with 104102 selected.
- Activity:** A list with 3, 4, and 5.
- Trip:** A list with 10410205, 10410210, and 10410215.
- Selection:** A query builder area with "Select From: Person" and "Where" clauses. It includes buttons for "Add", "And", "Or", "Remove", and "Clear".
- Person Query:** A search section with "Person" set to 104102 and "person\_activity\_before" selected. The search criteria are "person\_activity\_before" and "18:00:00". A "Seek" button is present.
- Summary:** "Activity Count" and "Trip Count" are both displayed as 6.
- Buttons:** "Show Diary", "Locate Activity", and "Locate All".
- Table:** A table with 6 columns: Activity\_Nbr, Activity, Location, Start Time, End Time, and Duration. It contains 3 rows of data.
- Quit:** A button in the bottom right corner.

Activity_Nbr	Activity	Location	Start Time	End Time	Duration
3	T	G1V3W5	08:51:00	11:59:00	03:08:00
4	D	G1X3Y2	12:05:00	12:59:00	00:54:00
5	T	G1V3W5	13:06:00	16:59:00	03:53:00

Figure 14. Time path of the current individual

Person

Household  
 1041  
 1071  
 1180

Person  
 104101  
 104102  
 104103

Activity  
 3  
 4  
 5

Trip  
 10410205  
 10410210  
 10410215

Selection  
 Select Group  
 Select From Person Where  
 Select field Select Operator Add  
 And  
 Or  
 Remove  
 Clear

Result Size

Person Query Activity Query Trip Query

Person  
 104102

Activity Count 6  
 Trip Count 6

Seek

Show Diary Locate Activity Itinerary Depict Path

Event Order	Event Class	Event id	Origin Or Loc	Mode Or Purpose	Event Start Time	Event End Time	Duration
1	Trip	10410205	G1X3Y2	C	08:45:00	08:50:00	00:05:00
2	Activity	3	G1V3W5	T	08:51:00	11:59:00	03:08:00
3	Trip	10410210	G1V3W5	C	12:00:00	12:04:00	00:04:00
4	Activity	4	G1X3Y2	D	12:05:00	12:59:00	00:54:00
5	Trip	10410215	G1X3Y2	C	13:00:00	13:05:00	00:05:00
6	Activity	5	G1V3W5	T	13:06:00	16:59:00	03:53:00
7	Trip	10410220	G1V3W5	C	17:00:00	17:04:00	00:04:00
8	Activity	6	G1X3Y2	D	17:05:00	18:29:00	01:24:00
9	Trip	10410225	G1X3Y2	C	18:30:00	18:35:00	00:05:00
10	Activity	7	G1V3W5	T	18:36:00	21:59:00	03:23:00
11	Trip	10410230	G1V3W5	C	22:00:00	22:04:00	00:04:00
12	Activity	8	G1X3Y2	D	22:05:00	08:44:00	10:39:00

Quit

Figure 15. Space-time path of the current individual

